



LED Lighting

Product Catalogue | 2016





Contents

History of the Company	4
Mitsubishi Lighting Material History	4
Our Philosophy	6
Verbatim LED Mission	7
Core LED Technology from Mitsubishi Chemical Corporation ...	8
Applications	10
Luminaires	13
- LED Recessed Downlights IP44	14
- LED Slim Recessed Downlights	18
- LED Recessed Downlights	22
- LED Recessed Spotlights IP44	26
- LED Track Lights	30
- Vx-Filter Technology for Verbatim LED Track Lights	38
- LED Panels	40
- LED Linear	46
- LED Batten Luminaires	50
Performance Lamps	55
- Classic A	56
- Mirageball Classic A	58
- Dichroic LED	62
- MR16 GU5.3	66
- PAR16 GU10	70
- Downlight Fittings for LED PAR16 GU10	76
- LED AR111	78
- LED T8 Tubes	84
Electronic Transformer for 12V LED lamps	88
Dimmer Compatibility Tool	89
Dialux PlugIn	89
Pictograms	90
Product Number Index	91

History of the Company

Introduction

Verbatim - Technology you can trust

From its foundation in 1969, the Verbatim brand has been at the forefront of technological innovation. In its early years, Verbatim focused on data storage and remains one of the most recognisable and respected brands in the industry. The company has a strong reputation as a trusted global supplier providing quality products backed up by fast and reliable service and support.

Mitsubishi ownership

In 2010, Verbatim entered the lighting industry and married Mitsubishi Chemical's 50 years of experience in developing lighting materials with its own extensive global sales and marketing network. Verbatim LEDs utilize unique technology developed by the Mitsubishi Chemical Group, including innovative optics, patented thermal management and knowledge of key materials to create high quality lighting solutions.

The result is a wide range of high quality LED lamps for professionals and consumers and an expanding portfolio of LED luminaires for daily use. Verbatim's products are designed to offer a high level of visual comfort, exceptional long term reliability and serve a broad range of applications.

Verbatim is deeply committed to serving its customers and continuing to develop market leading innovative solutions by incorporating unique technology developed by its parent company, Mitsubishi Chemical.

Mitsubishi Lighting Material History

Development Milestones

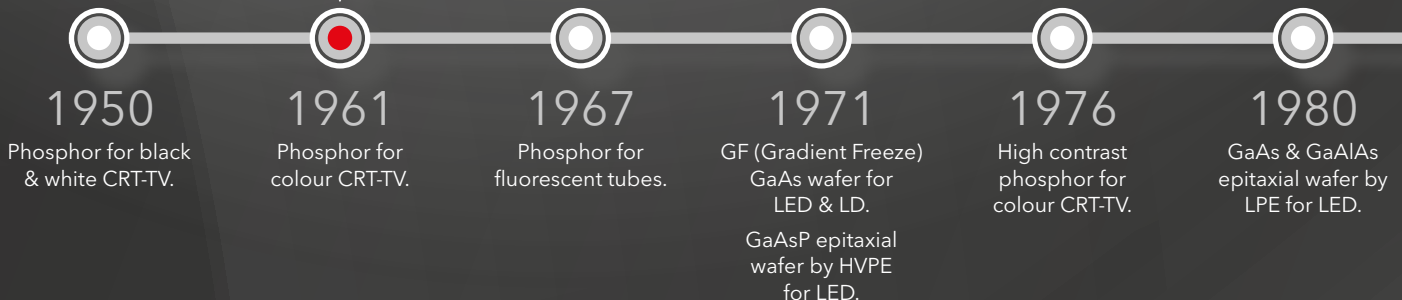



2014

Launch of OLED panel production by wet coating process. VxRGB technology.



2015

Launch of Mirageball optics, GU10/MR16 reflector lamps and unique AR111 with indirect light source.



2016

Vx-filter technology to increase CRI and vividness of colours.



2013

LED lamp using GaN on GaN technology. Establishment of MC Pioneer OLED Corporation, joint venture between MCC and Pioneer.

2012
Installed SCAAT™ large reactor. VxRGB white LED package for lighting.



2011

Nitride yellow phosphor for white LED (world's first commercialisation). Colour tunable OLED (world's first commercialisation).



2010

Alliance with Pioneer on OLED lighting business.

2009

Encapsulation material S-grade for LED. Start of manufacturing & sales of violet chip LEDs.

2008
GaN wafer by HVPE.

2006
Encapsulation material for LED.

1982

LEC GaAs wafer for high speed electronic device & LED.

1990

Natural colour phosphor for lighting. Phosphor for PDP-TV.

1993

780nm LD epitaxial wafer, chips for storage media.

1997

VGF GaAs wafer for LED & LD.

1998

980nm LD module for submarine communication. GaP epitaxial wafer by LPE for LED.

2005

Nitride red phosphor for white LED (world's first commercialisation).



KAITEKI

Our Philosophy

As part of the Mitsubishi Chemical Holdings Group, Verbatim follows the company's long term strategy and vision, summarized in the 'Kaiteki' Philosophy.

'Kaiteki', which traditionally means 'comfort' or 'ease' in Japanese, represents the global quality of life that will be made possible through sustainable technologies and breakthrough scientific advances in human healthcare.

Sustainability and respect for the environment are key elements of the KAITEKI concept: Verbatim's LED-based solutions help to achieve both.

When considering the sustainability of LEDs, in addition to their low energy use, they also offer benefits in terms of waste reduction, recyclability, the use of materials and resources and the effect on building and design practices. LEDs are mercury-free and very long lasting, which means less frequent replacement and reduced waste.

Verbatim LED Mission

By combining the research and development strengths of the Mitsubishi Chemical Group with the sales, marketing and distribution infrastructure of the Verbatim organization, we have formed a very powerful entity in the lighting industry.

Customer-centric organization: we can adapt quickly to customer needs in the fast changing lighting market.

Scientific insight: the Mitsubishi Chemical Group provides deep scientific lighting knowledge to allow us to utilize new proprietary technologies.

Specialists support: we benefit from expert groups within Mitsubishi Chemical including colour scientists, physicists, mechanical and optical engineers; Mitsubishi Colour Science focuses on the colour quality of

LEDs, and the Mitsubishi Optical Group provides support on various topics including minimizing glare from lamps.

Worldwide reach: as a worldwide organization, with subsidiaries on all continents, we possess a powerful global distribution and logistics network that can support all customer needs.

Corporate governance: we adhere to Mitsubishi Chemical Holdings strict and ethical approach to business, ensuring that we are a company you can trust for the long term.

Rigorous quality control: adherence to strict quality control standards enforced by Mitsubishi Chemical in Japan in close corporation with Verbatim's European quality control team in Germany.

OUR MISSION:

Provide reliable solutions in lighting technology for daily use.



Core LED Technology from Mitsubishi Chemical Corporation

Mitsubishi Chemical's experience and understanding of the four key technical elements of an LED lighting device ensures that the products are highly optimized and deliver the best in terms of efficiency and performance:

Electronics:

selection of high quality electronics for optimum power consumption, dimmer compatibility, control of light output and control of flicker.



Optimized thermal management:

maximizing efficiencies through careful choice of materials and unique product designs.

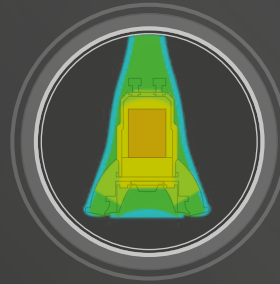

Unique optics:

beam angle, minimizing glare, visual comfort and light distribution optimized for various applications.



Key materials:

the Mitsubishi Chemical Group is a provider of premium quality materials including phosphors, engineering plastics, dyes for filters and c-GaN substrates.

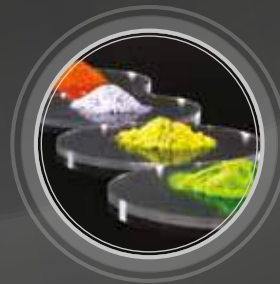

LED TECHNOLOGY



"A key development strategy at Mitsubishi Chemical is to focus on optimizing lumens per gram, thus maximizing the efficient use of materials in keeping with our Kaiteki principles. Verbatim has succeeded bringing to market a true incandescent lamp replacement, developing a world leading thermal management solution by combining an optimal heat sink, uniform light distribution and downsized optical designs resulting in high powered, small and light LED products.

We also seek to achieve this through the use of Mitsubishi's advanced raw materials. Every application needs the right mix of vividness, high colour rendering and low glare to deliver light of true quality.

Our decade-long dedication to research and science has been rewarded by over 70 patents related to LED lighting devices, establishing leadership in colour science and thermal management.

We are committed to continue on this path of launching technology innovations by continuously improving the quality, performance and design of our products. For this reason we are able to offer LED solutions which perfectly match customer requirements and are adapted to individual lighting tasks."

Akeo Kasakura

笠倉 暁夫

Akeo Kasakura
General Manager of LED Lighting Development Group
Mitsubishi Chemical Corporation

Applications

Verbatim LED lighting solutions can be used across a wide range of applications. They are ideal for home and commercial applications including shops, offices, hotels and restaurants.

RETAIL

Lighting is critical in creating a memorable customer shopping experience and showcasing merchandise appealingly. Creating contrasts with light and shadow, showcasing vivid colours or guiding customer sightlines through the shop are all aspects of professional lighting. Whether ambient or accent lighting, Verbatim LEDs offer high vividness and high colour rendering solutions which help to bring out the best from the colours on display. With long opening hours, retail lighting is in operation for most of the day so in addition to improving the ambiance of the store, significant cost savings can be achieved by retailers investing in LED lighting.



HOSPITALITY

Providing the best customer experience is a goal in any hospitality environment and setting the appropriate mood for each space is a key requirement. Verbatim products achieve this with a range of high quality lamps and luminaires. Another objective for any business owner is to minimise costs, and by moving to Verbatim LEDs with their long lifetimes and superior efficiency, maintenance and energy bills will be dramatically reduced.

OFFICE

Workplaces should be comfortable homogeneous environment, delivering optically pleasing lighting solutions. Office workers spend many hours a day exposed to artificial light, making low glare and visual comfort an important influencing factor in their productivity. LEDs offer longer lifetime as well as substantially lower energy consumption compared with conventional lighting making LED installation not only a visually attractive choice, but one with a high return on investment. In addition, our dimmable products give even more flexible lighting options for work spaces.



RESIDENTIAL

Lighting sets the mood in your home. Our professional dimmable LEDs give you the opportunity to control the light scenes to match the occasion. The simplicity of retrofit solutions makes installation easy. Whether you want to highlight architectural design or create lighting schemes sympathetic to your lifestyle, our LEDs offer maximum flexibility, long life and very low energy consumption.





Luminaires

Verbatim LED luminaires are suitable for a broad range of professional lighting applications including hotels and restaurants to offices, retail stores and warehouses. Ideal for new lighting installations or upgrade projects, Verbatim's attractive luminaires offer fast and easy fitting with compact housing dimensions, excellent visual comfort, high efficacy and long lifetime.



LED Recessed Downlights IP44

A high quality range of LED downlights featuring different diameters and wattages with a maximum luminous flux of 3900lm. The high lumen output makes the downlight especially suitable for environments with ceiling heights of >3m. As only a small number of luminaires are needed to achieve the required illuminance level, it results in less maintenance cost and reduced installation effort and time.

With a protection class rated IP44 the product is equally suitable for more exposed environments such as damp rooms and covered outdoor areas.

A flicker-free, 1-10V dimmable driver together with a solid aluminium heatsink and a deep-recessed white trim combine to create a high spec, attractive downlight.



Application

A direct replacement for downlights incorporating compact fluorescent lamps. General lighting for corridors, entry halls and retail environments. Especially suitable for spaces with room heights $\geq 3,00\text{m}$. Suitable for most suspended ceilings with a thickness of $\leq 25\text{mm}$.

52493 / 52497

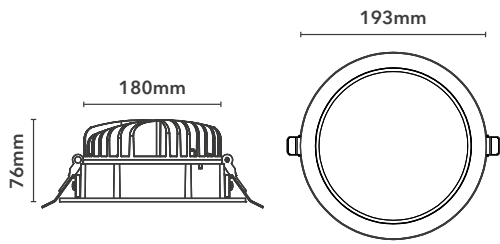

52494 / 52498

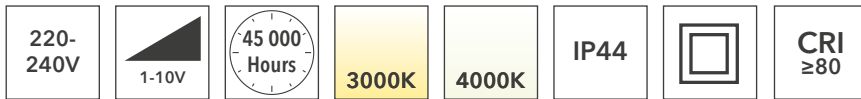
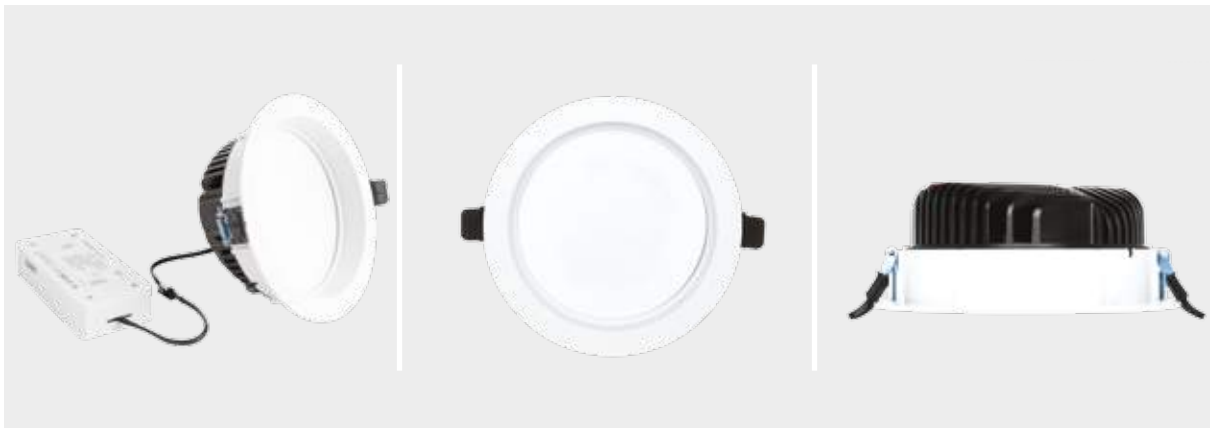
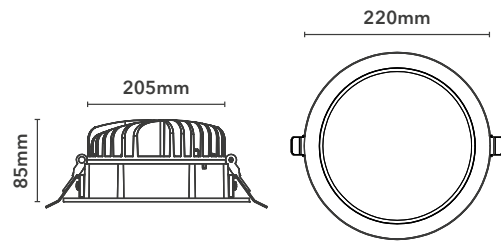

Product Number	Wattage (W)	Luminous Flux (lm)	CCT (K)	Product Weight (g)
52493	35	2900	3000	1164
52494	40	3800		1437
52497	35	3000	4000	1164
52498	40	3900		1437

LED Recessed Downlights IP44 Photometric Data

52493

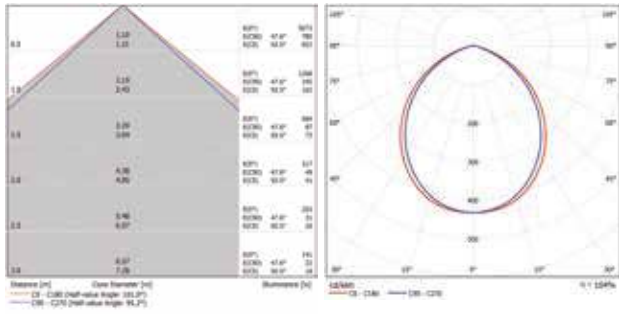

52497

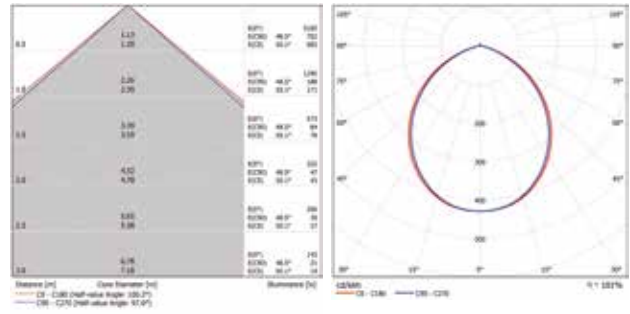

52494

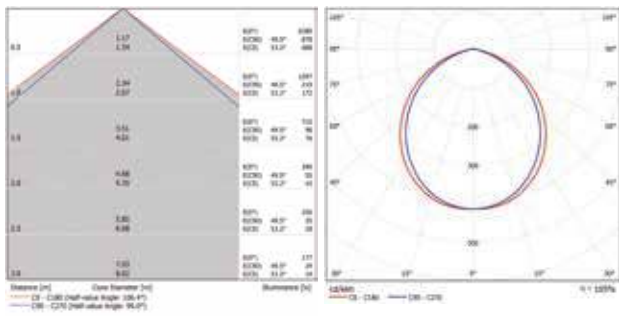

52498

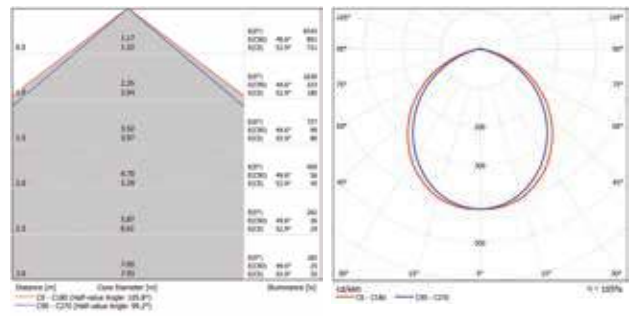



LED Slim Recessed Downlights

Verbatim LED slim recessed downlights, with their extremely shallow depth (<33mm), are suitable for environments with height restrictions or limited void space. They use a high quality PC-diffuser formulated with evenly dispersed diffusion particles that results in uniform and diffuse general lighting while at the same time passing the 850°C glow wire safety test.

The elegant simplicity in design and white housing enables discreet integration into suspended ceilings. A dimmable driver, 40,000 lifetime, and tool-free installation makes it a perfect replacement for conventional downlights containing compact fluorescent lamps.



Application

A direct replacement for compact fluorescent downlights. General lighting for corridors, hotels and shops. Suitable for suspended ceilings with a thickness of 5-18mm.

52267 / 52270

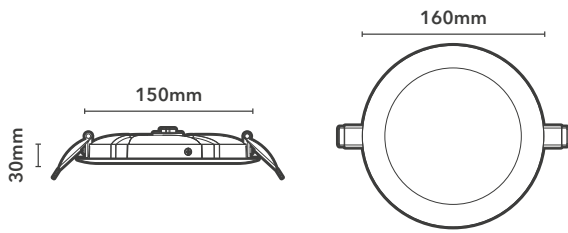

52268 / 52271

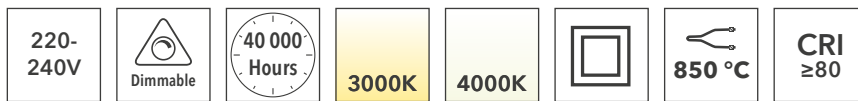
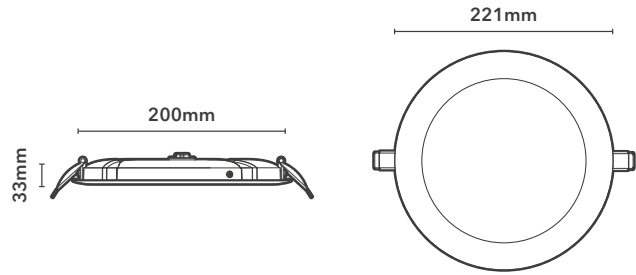

Product Number	Wattage (W)	Luminous Flux (lm)	CCT (K)	Product Weight (g)
52267	16	1450	3000	420
52268	25	2250		620
52270	16	1500	4000	420
52271	25	2300		620

Go to www.verbatimlighting.com for dimmer compatibility information

LED Slim Recessed Downlights Photometric Data

52267

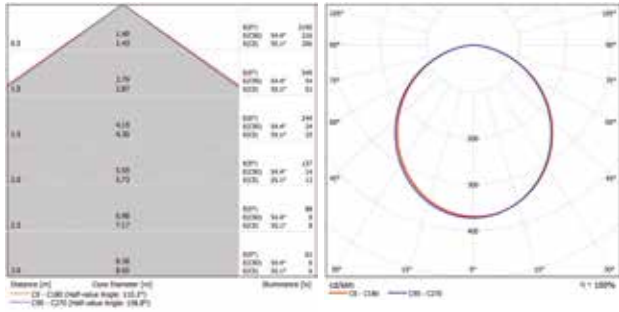

52268

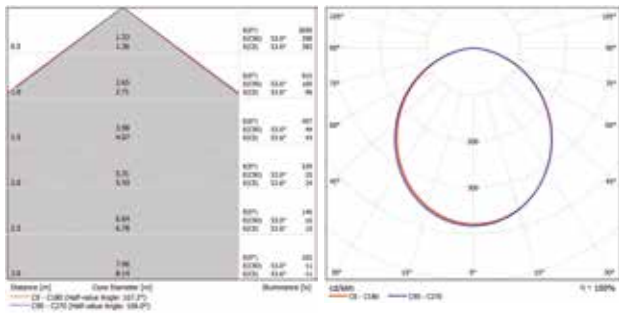

52270

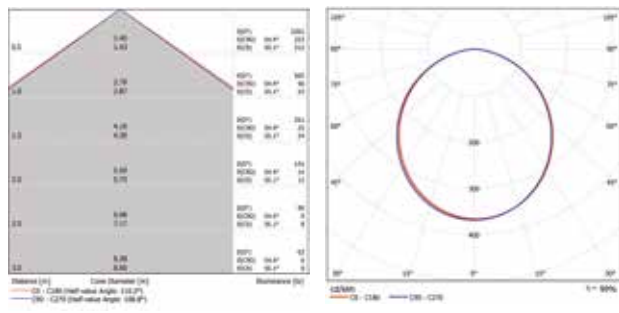

52271

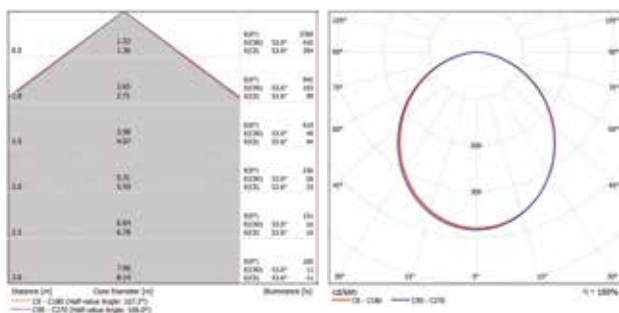



LED Recessed Downlights

Verbatim LED recessed downlights for general lighting offer a uniform, homogeneous light distribution. They come in four different diameters and are easy to integrate. They are compact in size and possess an external power supply. The white housing ensures discreet integration in ceilings.

Full metal housing guarantees efficient thermal management. 40,000 hours lifetime and excellent energy efficiency makes it a perfect replacement for downlights containing compact fluorescent lamps.

Dimming options available with corresponding dimmable drivers.



Application

A direct replacement for compact fluorescent downlights. General lighting for corridors, offices, hotels and restaurants. Suitable for most suspended ceilings with a thickness of $\leq 20\text{mm}$.

52444 / 52448

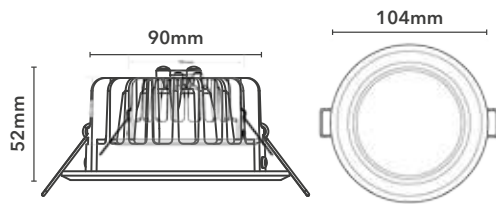

52446 / 52450

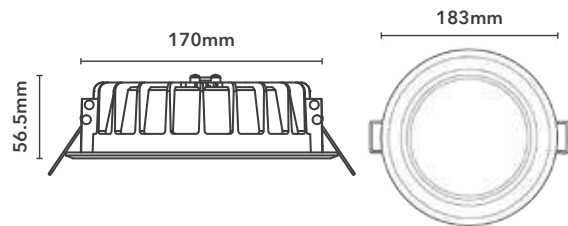

52445 / 52449

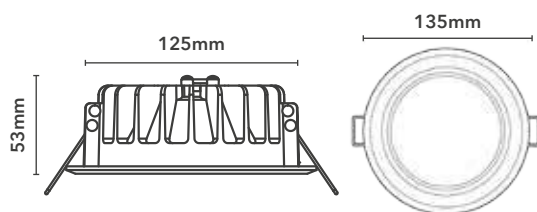

52447 / 52451

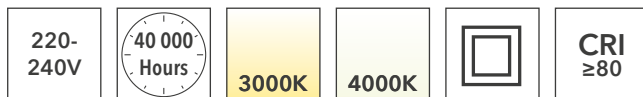
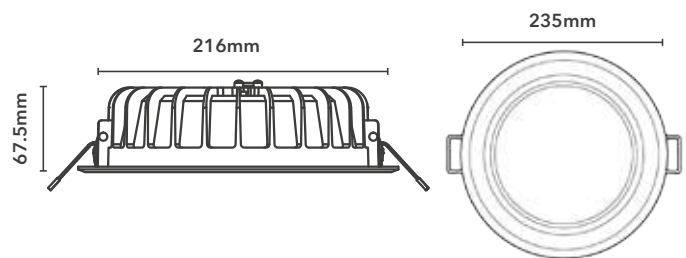

Product Number	Wattage (W)	Luminous Flux (lm)	CCT (K)	Dimmable	Product Weight (g)
52444	11	800	3000	with 52912	174
52445	15	1200		with 52913	286
52446	21	1800		with 52914	476
52447	24	2050		with 52915	796
52448	11	850	4000	with 52912	174
52449	15	1250		with 52913	286
52450	21	1900		with 52914	476
52451	24	2150		with 52915	796

Accessories

Dimmable* drivers for recessed downlights:

52912 - for 11W

52913 - for 15W

52914 - for 21W

52915 - for 24W

*leading and trailing edge

Go to www.verbatimlighting.com for dimmer compatibility information





LED Recessed Spotlights IP44

Verbatim LED recessed spotlights for spot or accent lighting are available in 3000K and 4000K with a beam angle of 40°. The diamond cut optics provide precise and glare free light distribution. Dimmable and easy to integrate thanks to its compact dimensions and external power supply. The protection class IP44 guarantees a broad field of application. Available in two housing colours, white or silver.



Application

A direct replacement for halogen spotlights. For accent lighting in reception areas, hotels, restaurants as well as damp rooms and protected outside areas. Suitable for most suspended ceilings with a thickness of $\leq 25\text{mm}$.

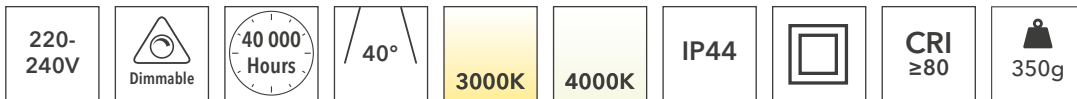
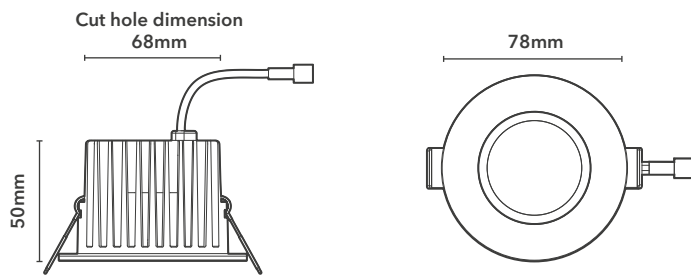

Product Number	Wattage (W)	Luminous Flux (lm)	Luminous Intensity (cd)	CCT (K)	Housing Colour
52408	10	810	1150	3000	White
52409		840	1200	4000	
52410		810	1150	3000	Silver
52411		840	1200	4000	

Go to www.verbatimlighting.com for dimmer compatibility information

LED Recessed Spotlights IP44 Photometric Data

52408 / 52410

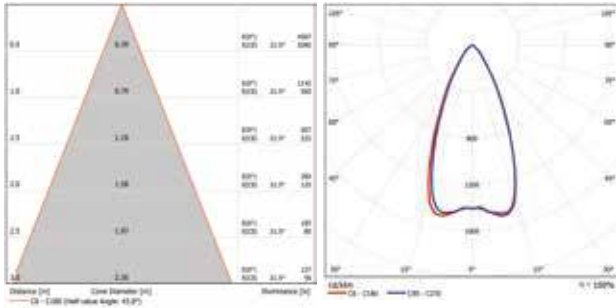

52409 / 52411

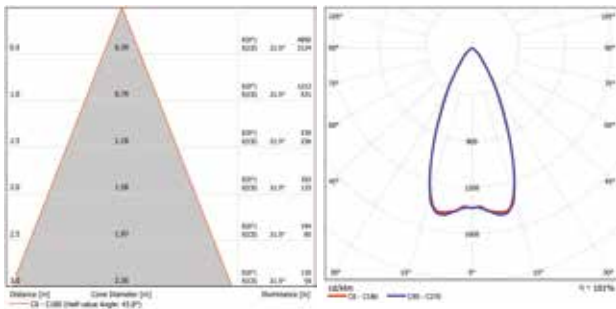



LED Track Lights

Verbatim LED track lights for accent lighting offer maximum flexibility with 350° rotation and 180° tilting angle. Easy to integrate into three circuit track systems due to its GLOBAL pro track adaptor and compact dimensions.

The LED track lights feature different power ranges and colour temperatures for various applications. Available with a range of accessories for glare prevention and narrow beam angles.

35,000 hours lifetime and excellent energy efficiency makes them a perfect replacement for metal halide lighting equivalents.



Application

A direct replacement for track lights using metal halide lamps. For accent lighting in retail environments, museums and galleries. Suitable for GLOBAL pro track systems.

52436 / 52437

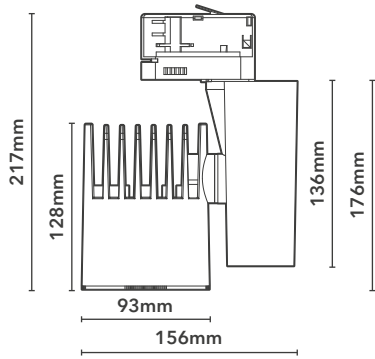

52438 / 52439

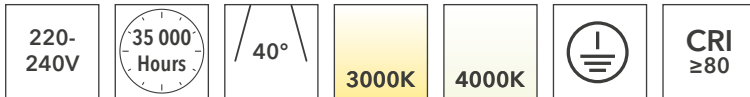
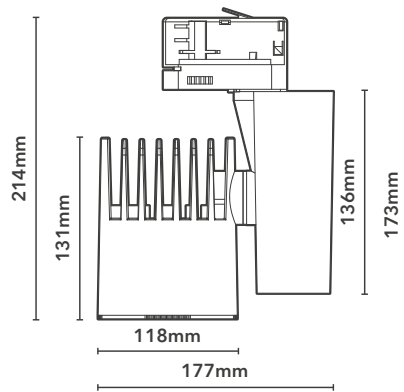

Product Number	Wattage (W)	Luminous Flux (lm)	Luminous Intensity (cd)	CCT (K)	Tilting Angle (°)	Product Weight (g)
52436	25	1750	3000	3000	180 / 350	1150
52437		1900	3300	4000		
52438	40	3000	6000	3000		
52439		3100	6500	4000		1570

Black and silver housing available on request

Accessories

Spot reflectors 25° for LED Track lights*:
52906 - for 25W, 52909 - for 40W

Honeycomb louver for LED Track lights:
52908 - for 25W, 52911 - for 40W

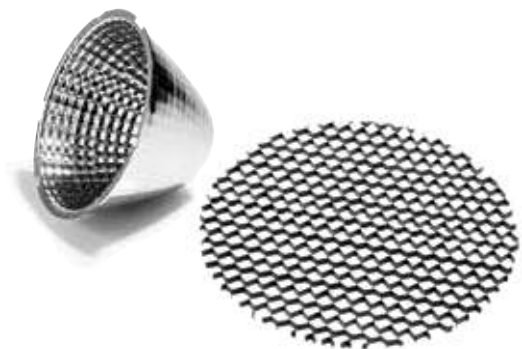

*Please request photometric data for 25° reflectors

LED Track Lights Photometric Data

52436

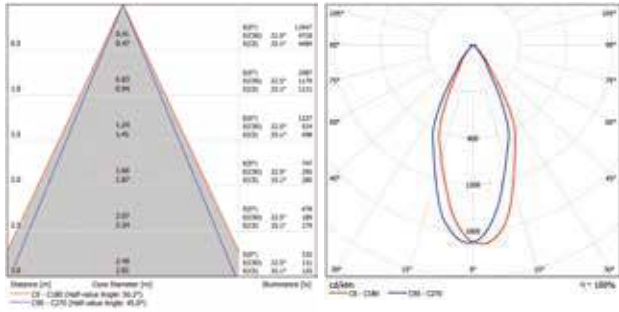

52437

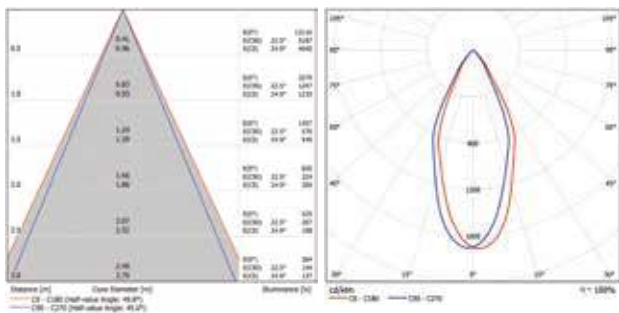

52438

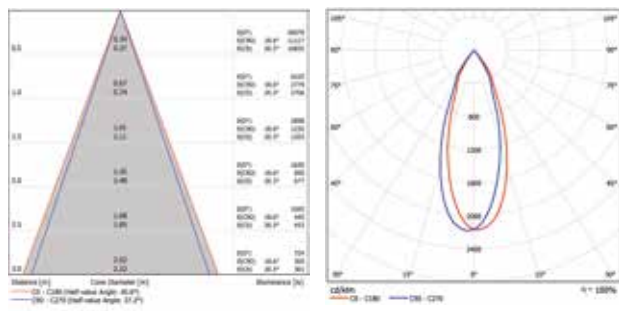

52439

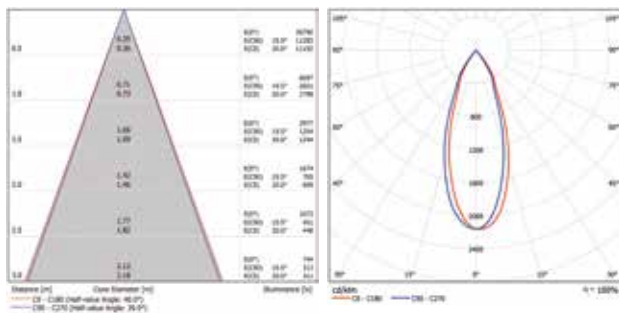



LED Track Lights

LED track lights for accent lighting offering maximum flexibility with 350° rotation and 180° tilting angle. Easy to integrate into three circuit track systems thanks to its GLOBAL pro track adaptor and compact dimensions.

Verbatim LED track lights feature different power ranges and colour temperatures for various applications. Available with a range of accessories for glare prevention and narrow beam angles.

The appealing and discreet design make them suitable for situations in which the luminaire should appear as unobtrusive as possible. 50,000 hours lifetime, excellent energy efficiency and dimming options make them a far better alternative to metal halide lighting equivalents.

Equipped with Mitsubishi Chemical's Vx-filter (see page 38).



Application

A direct replacement for track lights using metal halide lamps. For accent lighting in retail environments, museums and galleries. Suitable for GLOBAL pro track systems.

52452 / 52453

52454 / 52455

52456 / 52457

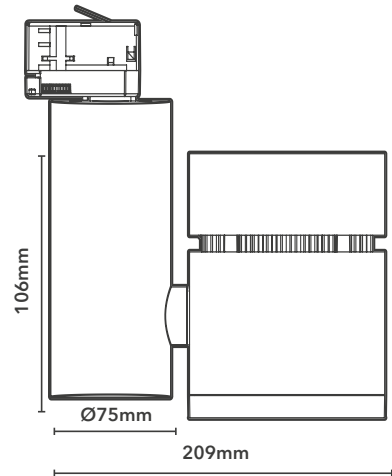
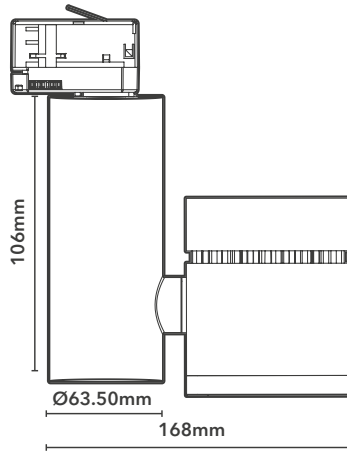
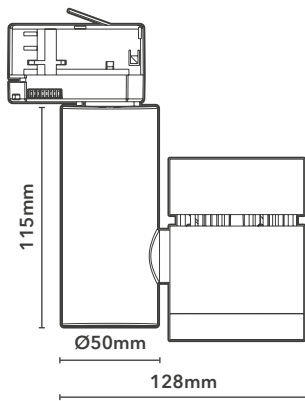

Product Number	Wattage (W)	Luminous Flux (lm)	Luminous Intensity (cd)	CCT (K)	Tilting Angle (°)	Product Weight (g)
52452	15	1200	2500	3000	180 / 350	640
52453		1300	2700	4000		
52454	28	2400	6000	3000		1000
52455		2600	6500	4000		
52456	48	4100	7200	3000		1700
52457		4600	8200	4000		

Black and silver housing available on request

Accessories

Spot reflectors 20° for LED Track lights*:
 52917 - for 15W, 52918 - for 28W, 52919 - for 48W

Anti-glare snoot for LED Track lights:
 52920 - for 15W, 52921 - for 28W, 52922 - for 48W

*Please request photometric data for 20° reflectors



Go to www.verbatimlighting.com for dimmer compatibility information

LED Track Lights Photometric Data

52452

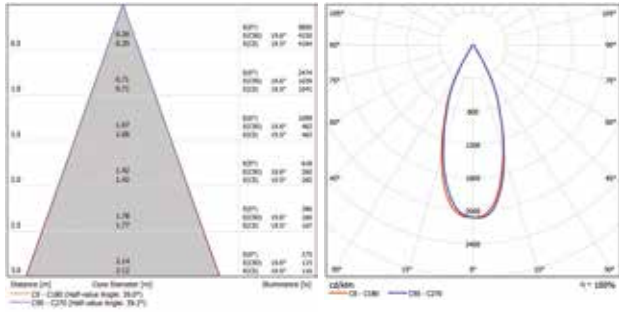

52455

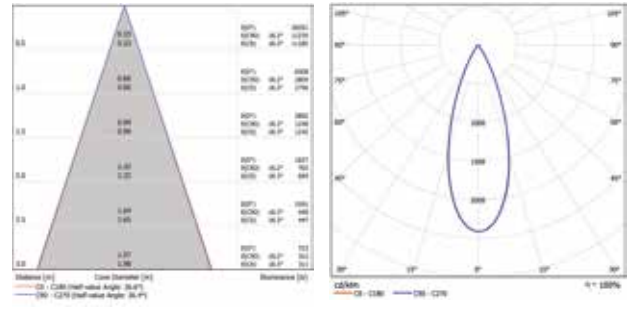

52453

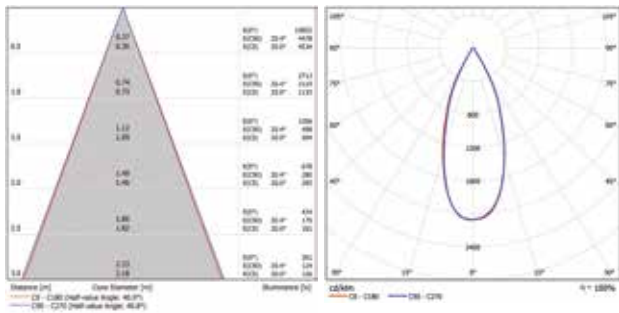

52456

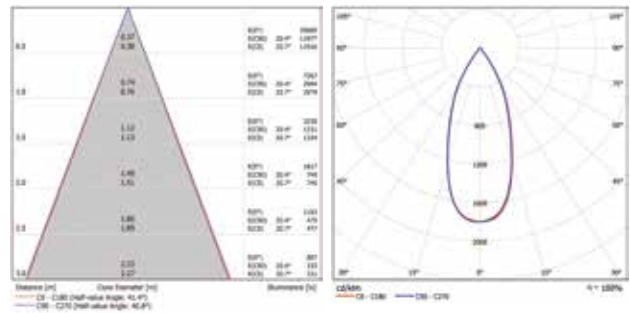

52454

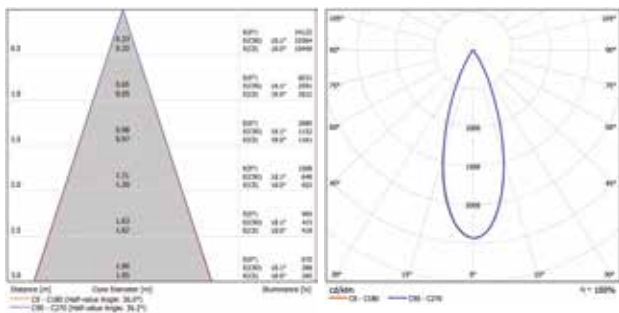

52457

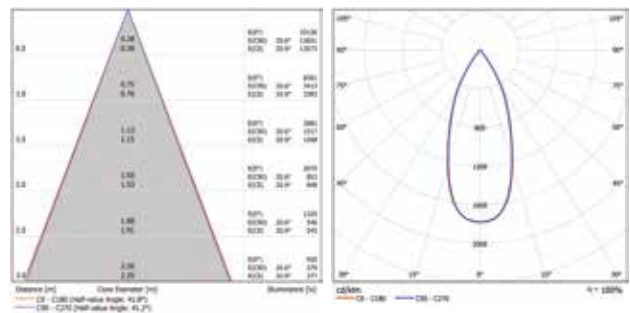



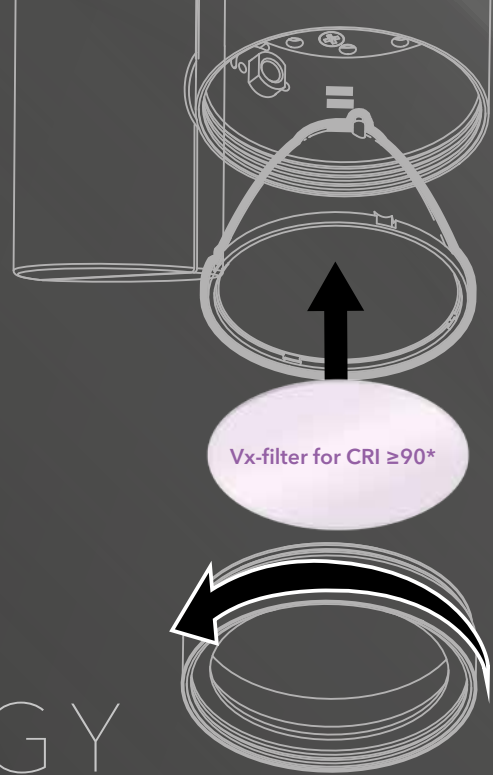

VX-FILTER TECHNOLOGY

for Verbatim LED Track Lights

Using proprietary technology from Mitsubishi Chemical, Verbatim's LED track lights (see page 34) are equipped with an innovative filter to simultaneously boost the colour rendering index (CRI) and vividness of colours perceived

The Vx-filter delivers precise changes to the spectral distribution curve to ensure that colours and finer details of objects appear as they would be perceived in natural daylight. Designed specifically in accordance with the spectral sensitivity of the human eye, this technology delivers truly outstanding visual perception.

Vx-filter technology provides the flexibility to tune Verbatim LED track lights at a later stage to meet the individual requirements of an installation. Equipped with the Vx-filter, they deliver superb colour rendering properties, but a high efficacy option is also available by just removing the filter.

Made from DURABIO™, the bio-based engineering plastic developed by Mitsubishi Chemical, the Vx-filter has excellent optical properties such as high transparency and superb light transmission.

With an exceptional lifetime of 50,000 hours, the accessory also features high heat and excellent scratch and UV resistance.



* Luminous Flux (lm) with Vx-filter: ~ -20% to -25%
Colour Temperature (K) with Vx-filter: ~+10%
Colour Rendering Index (CRI) with Vx-filter: ~+10

The improvement in colour fidelity and vividness is a solution that is particularly useful for retail environments, museums and hospitality venues - in spaces where small differences in colour hues, tints and textures can have a significant impact.

With Vx-filters, the CRI increases by +10, from CRI \geq 80 up to CRI \geq 90.

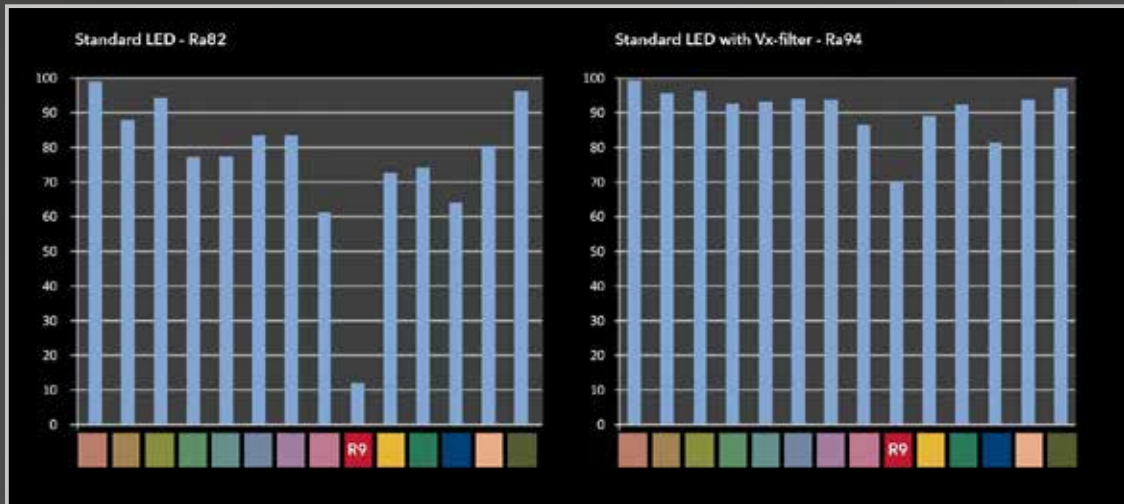

How faithfully colours are rendered with Vx-filter is shown by the 99 colour evaluation samples used to determine TM-30-15. With a Fidelity Index (Rf) of 88 (3000K) and 87 (4000K), an outstanding quality of light is achieved.

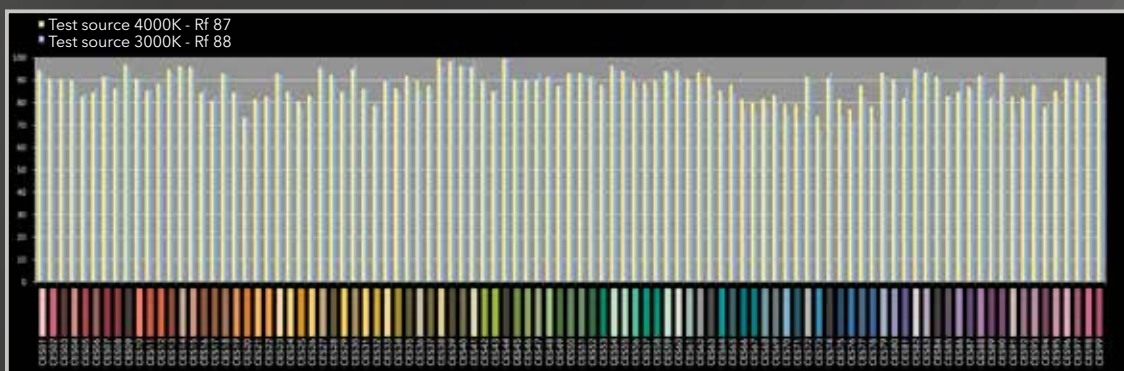

Another indicator that determines the saturation of colours and thus the chroma variation with Vx-filters is the Gamut Index (Rg). With a Gamut Index of >100, colours appear more saturated and vibrant as they would do under daylight.

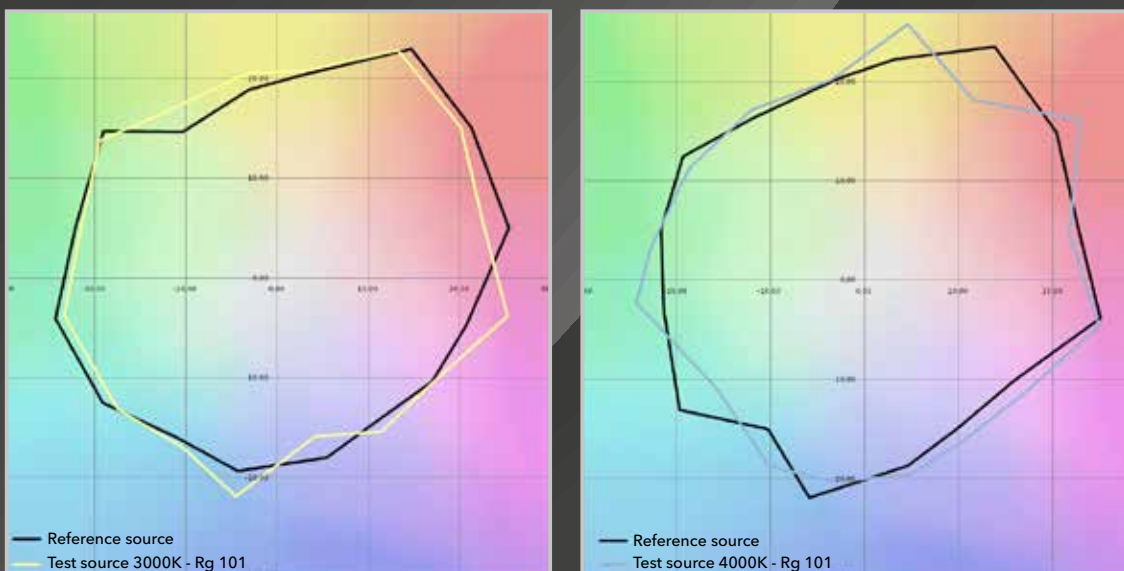

LED Panels

These energy efficient, flicker-free LED panels benefit from Mitsubishi's technical know-how in plastic materials. They feature Mitsubishi Chemical's light guiding plate which was developed specifically for edge-lit illumination offering superior long path light transmission as key property to achieve luminous efficacies of 100 lm/W, perfect evenness of illumination and excellent homogeneity.

Available in four different sizes and two different types of diffusers, these luminaires do not only offer a solution to avoid uncomfortable glare in workspace areas (UGR<19) but also an option that passes the glow wire safety test at 850°C to meet fire regulations in corridor, hallways and other fire escape routes.

50,000 hours lifetime and a DALI dimming option makes it a perfect replacement for fluorescent lighting equivalents. A broad range of mounting accessories offers flexibility in installation, but they can also be laid directly into gridded ceilings.



Application

A direct replacement for panels with fluorescent tubes. For general lighting in offices, schools, universities and other workspaces. Suitable for most ceiling grids.

52246 / 52247

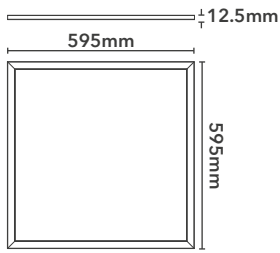

52248 / 52249

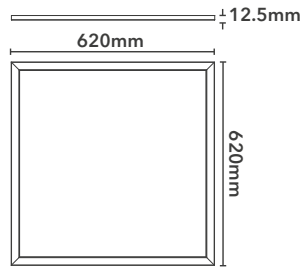

52250 / 52251

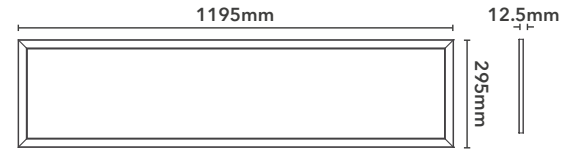

52258 / 52259

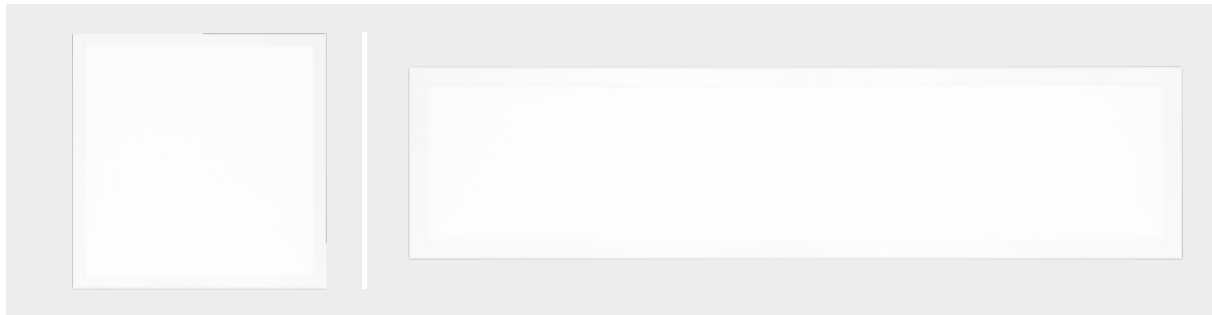
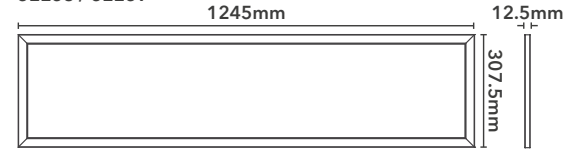

Product Number	Wattage (W)	Luminous Flux (lm)	UGR	Glow Wire Test (°C)	Product Weight (g)
52246	40	4000	>19	850 °C	3000
52247			<19	650 °C	
52248			>19	850 °C	3200
52249			<19	650 °C	
52250			>19	850 °C	3300
52251			<19	650 °C	
52258			>19	850 °C	3500
52259			<19	650 °C	

Accessories



52902
Verbatim LED Driver
for 40W LED Panel



52903
Meanwell LED DALI
Driver for 40W
LED Panel
Also offers six preset
outputs by dipswitch.



52925
Suspension Kit for
40W LED Panel
600x600/625x625
52927
Suspension Kit for
40W LED Panel
1200x300/1250x312.5



52926
Recessed-mounting
clips for 40W LED Panel
600x600/625x625
52928
Recessed-mounting
clips for 40W LED Panel
1200x300/1250x312.5



52924
Surface-mounting frame
for 40W LED Panel
600x600



LED-Panels Photometric Data

52246

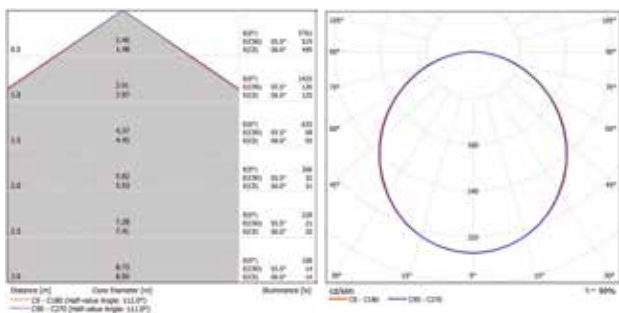

52250

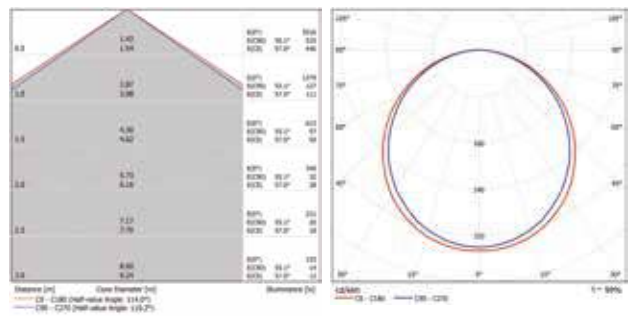

52247

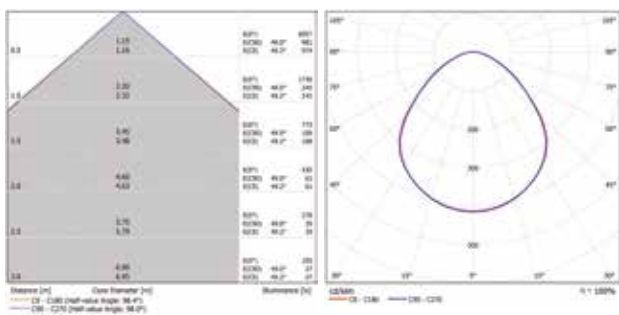

52251

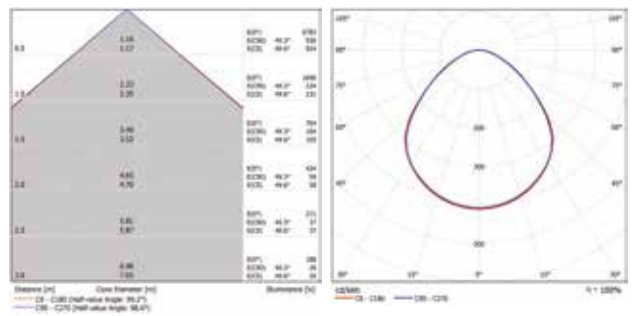

52248

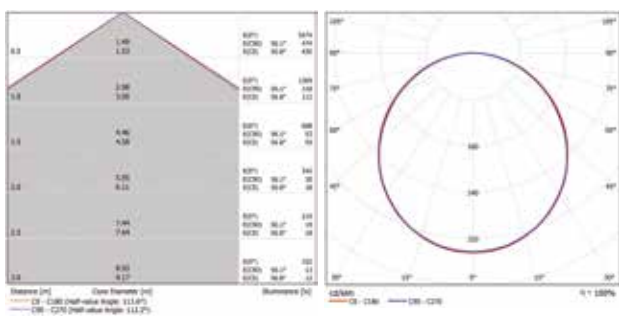

52258

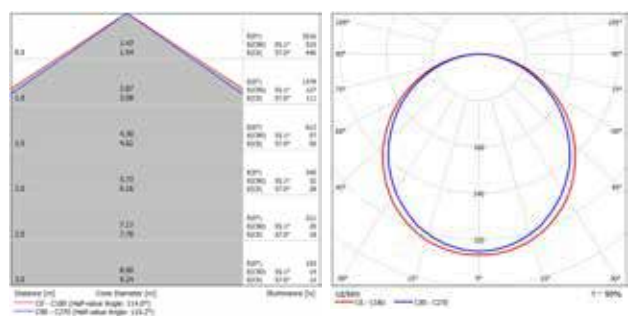

52249

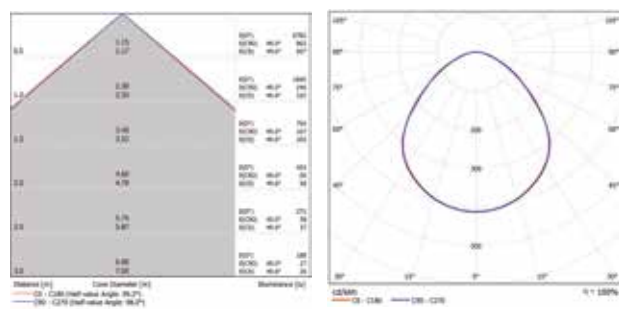

52259

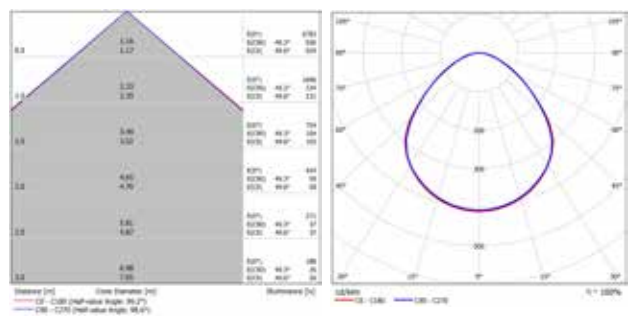



ADVANCED PRODUCT DESIGN

Mitsubishi Chemical's light guiding plate for LED panels

Verbatim LED panels consist of a multi-layered set-up in which the aluminium frame and back plate provide structural support and heatsink functionality. The optical system features edge-lit technology with high quality LEDs and a premium light guiding plate. A choice of two different diffuser finishes round off the elegant, minimalistic appearance of the luminaire.

With an optical system being the determining factor of the luminaire, they benefit from Mitsubishi's technical know-how in plastic materials. The LED panels feature Mitsubishi Chemical's light guiding plate; a light-guiding acrylic sheet produced from a special, high quality continuous cast sheet formula, developed specifically for edge-lit illumination, giving excellent evenness of illumination. Bright, thin and energy efficient - requiring less energy to illuminate large areas.

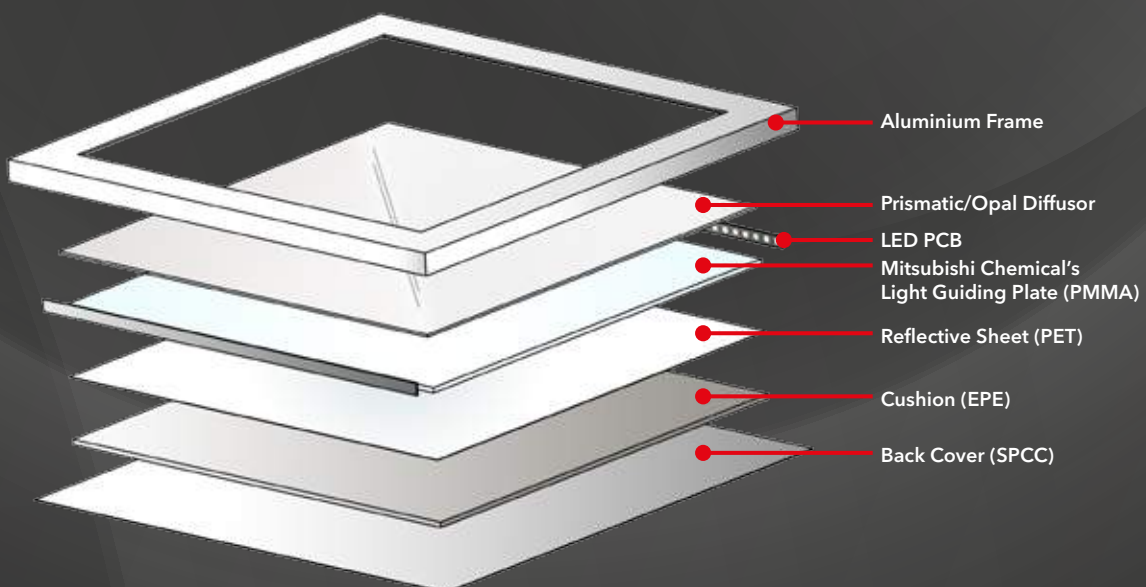



Excellent homogeneity of Mitsubishi Chemical's light guiding plate results in evenness of illumination. Light is inserted in the edge of the light guiding plate and propagated via total internal reflection. Two different types of diffuser scatter light appropriate to the need of application.

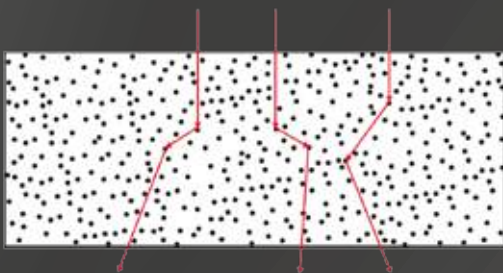

Opal diffuser, fire-resistant polycarbonate diffuser, formulated with evenly dispersed diffusion particles resulting in uniform homogeneity. Excellent resistance to ignition and reduced fire risk due to self extinguishing properties. Glow wire test according to IEC 60695-2-11: 850°C.

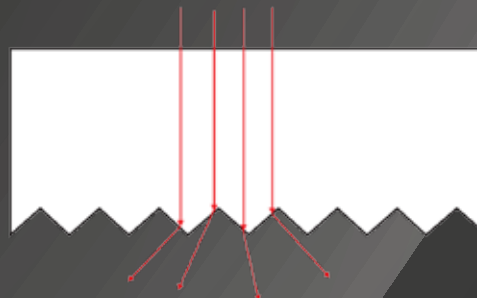

Microprismatic diffuser engineered to deliver a photometric output that complies with the 65° cutoff requirement. In accordance with EN12464, reducing glare to a comfortable working environment (UGR<19) especially suitable for office applications. Controlled luminance and perfect visual comfort for avoiding decreased effectiveness and visual fatigue.

LED Linear

Linear LED lighting system for general architectural lighting.

Homogeneous light emission thanks to the opal polycarbonate diffuser which passes the glow wire test at 850°C. White coloured luminaire housing made of extruded aluminium profile.

Modular lighting system for direct mounting on ceilings and walls, available in three lengths and two colour temperatures. Installation as seamless line is possible. Accessory kits for recessed-mounting and suspension allows various configurations in installation.

Supplied by default with a flicker-free, non-dimmable driver.

Excellent energy efficiency, a long lifetime of 50.000 hours and a narrow binning of SDCM ≤ 3 make it a perfect replacement for linear lighting systems with conventional fluorescent tubes.



Application

Suitable for general lighting in public and commercial buildings, retail and hospitality.

52278 / 52281

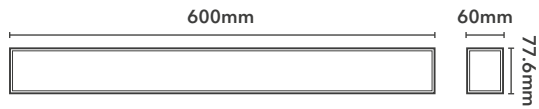

52479 / 52482

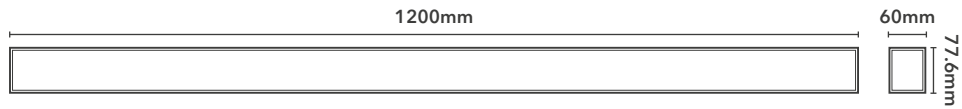

52280 / 52283

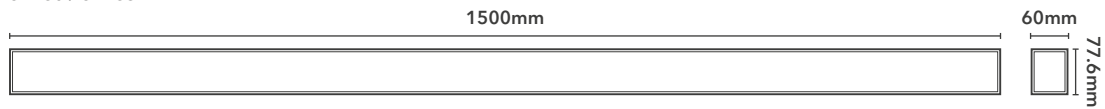

Product Number	Wattage (W)	Luminous Flux (lm)	CCT (K)	Product Weight (g)
52278	12	1150	3000	1300
52281		1200	4000	
52279	24	2400	3000	2200
52282		2500	4000	
52280	30	3000	3000	2680
52283		3100	4000	

Accessories



52932- Verbatim Suspension Kit for LED Linear



52933 - Verbatim Recessed-Mounted Kit for LED Linear

52929 Tridonic LED DALI Driver for 600mm LED Linear
 52930 Tridonic LED DALI Driver for 1200mm LED Linear
 52931 Tridonic LED DALI Driver for 1500mm LED Linear

LED Linear Photometric Data

52278

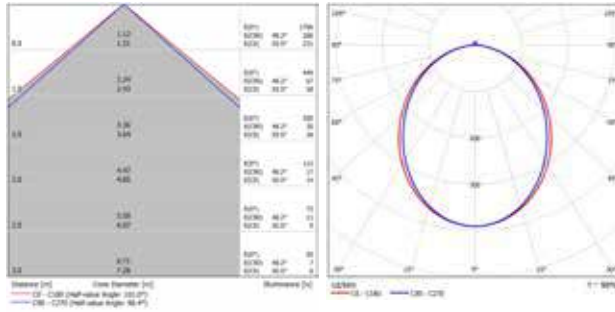

52281

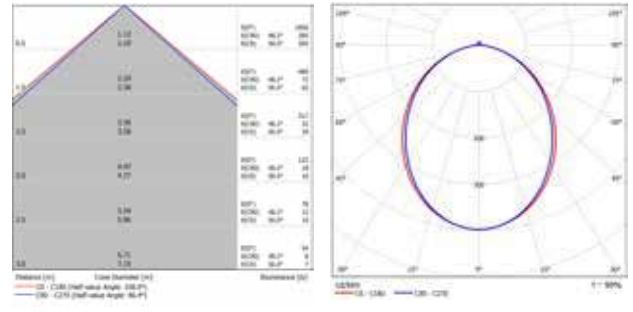

52279

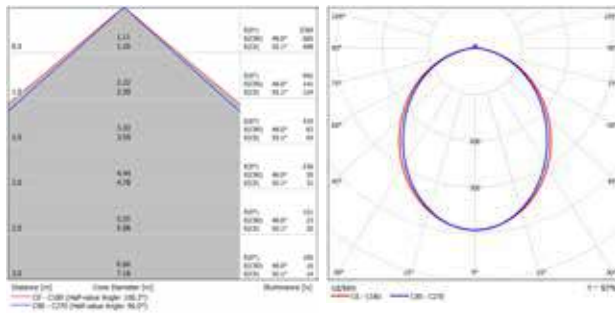

52282

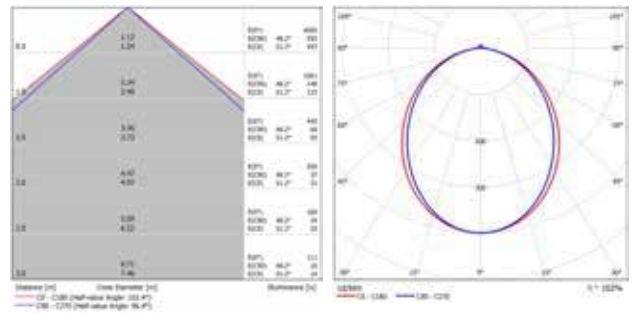

52280

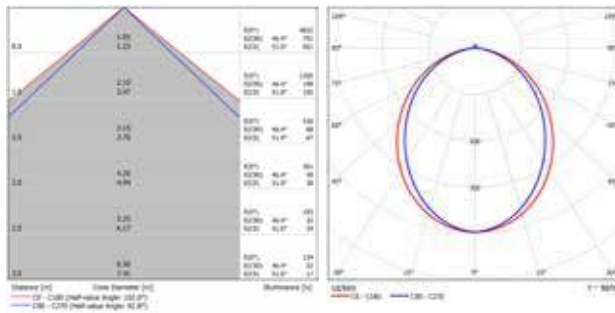

52283

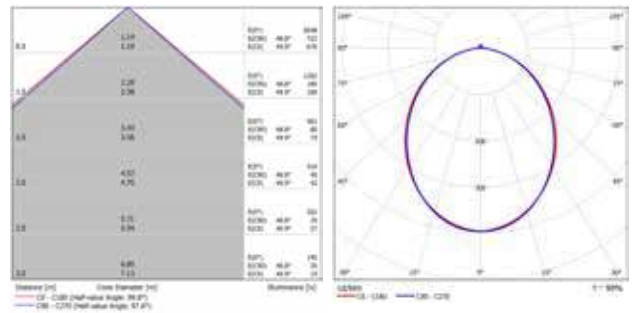



LED Batten Luminaires

Energy efficient alternative for batten luminaires containing fluorescent tubes. Durable, maintenance-free and reliable. Verbatim LED batten luminaires offer a high-quality solution for general lighting in technical environments.

These IP65 batten luminaires provide not only protection against moisture and dust but also impress with an aesthetic design and excellent functionality. Mounted either directly on the ceiling or suspended with the corresponding chain suspension, these luminaires fit in various applications. Only recommended for use with Verbatim LED T8 Tubes.



Application

A direct replacement for batten luminaires containing fluorescent tubes. For general lighting in car parks, garages, sports areas, workshops and warehouses.

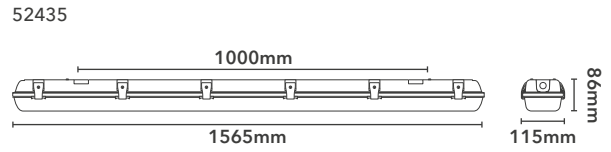
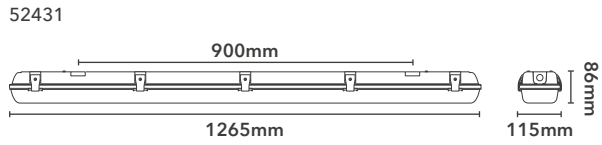
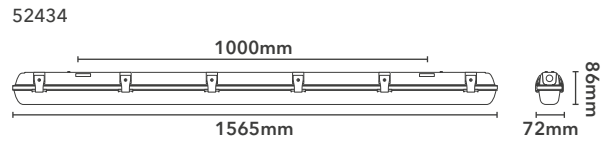
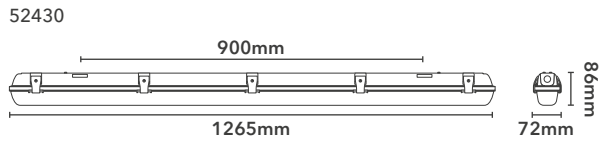

Product Number	Fitting	Product Weight (g)
52430	Single	1100
52431	Twin	1650
52434	Single	1650
52435	Twin	2150

Recommended for use with Verbatim LED T8 Tubes - please refer to page 84

Accessories



52905 - Chain suspension for Batten Luminaire IP65

LED Batten Luminaires Photometric Data

52430

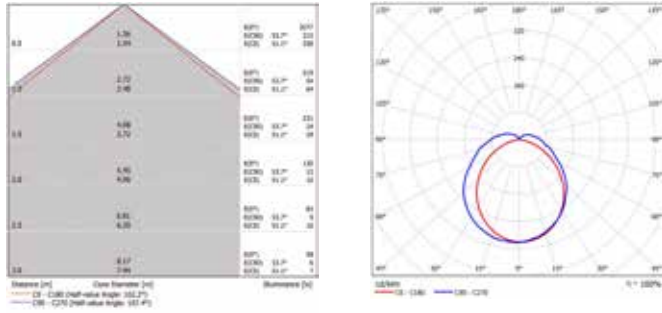

52431

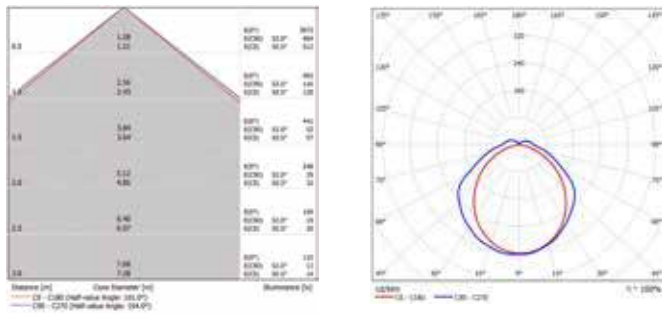

52434

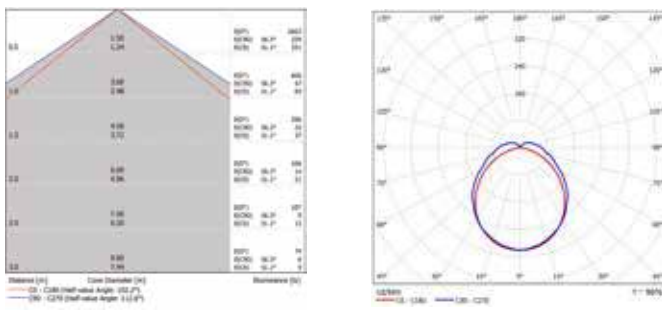

52435

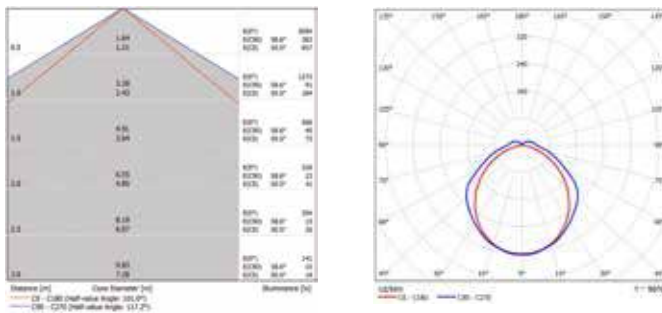







Performance Lamps

Verbatim's LED performance lamps provide a direct replacement for current incandescent and halogen lamps. They offer outstanding light performance for a wide range of applications, significantly reducing energy and maintenance costs.

LED lamps for the professional installer with a wide range of beam angles, long lifetime and colour temperatures to suit all applications.



Classic A

The new Verbatim Dimmable Classic A offers light with great light distribution and a good dimming capability. Its broadly distributed light makes your space bright and cosy in an efficient way. This is the perfect product to replace the popular 60W, 75W and 100W incandescent lamps.



Application

Suitable for a wide range of applications in the home, hotels or other public spaces.

52336

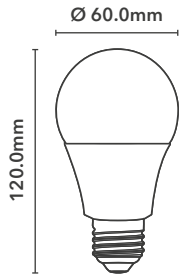

52337 / 52338 / 52339

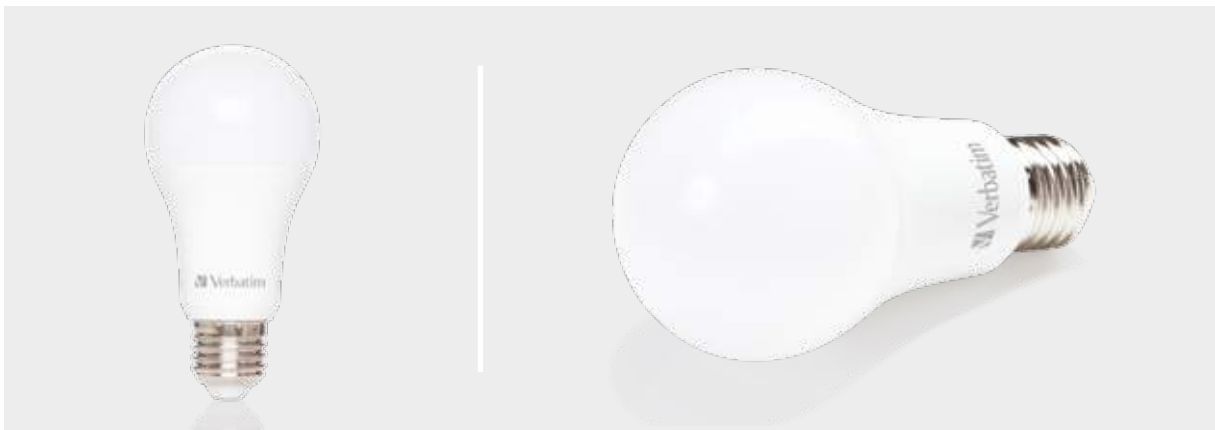
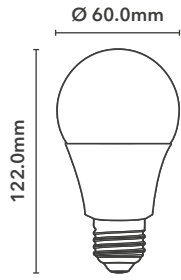

Product Number	Wattage (W)	Equivalent Wattage (W)	Luminous Flux (lm)	Luminous Intensity (cd)	CCT (K)	Beam Angle (°)	Product Weight (g)	Power Factor
52336	9.5	60	810	85	2700	240	76	≥0.90
52337	12	75	1060	120				
52338	13.5	100	1520	205	3000	200	126	
52339		100		4000				

Classic A Photometric Data

52336

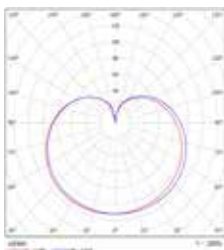

52337

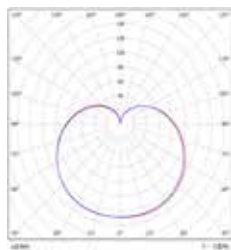

52338

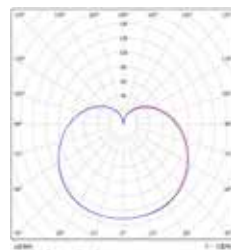

52339

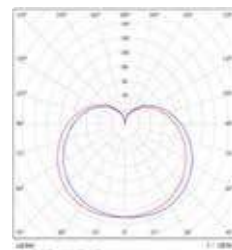

Go to www.verbatimlighting.com for dimmer compatibility information

Mirageball Classic A

Verbatim LED Classic A E27 Mirageball is a design oriented Classic A lamp with a special focus on aesthetics. Mirageball provides an elegant and attractive lighting effect, transforming rooms into warm and comforting spaces thanks to its uniform omnidirectional shadow-free light distribution.

Dimmable Mirageball lamps offer a soft, warm ambience and harmonious light to create an intimate space.

To ensure the lighting presents extra warmth and ambience, the Mirageball LED lamps feature a colour temperature of 2500K rather than the typical 2700K or 3000K of Classic A lamps.



Application

Ideal for decorative fixtures where a very even and wide angled light distribution is necessary. The clear and beautiful warm white light creates a pleasing illumination and ambience.

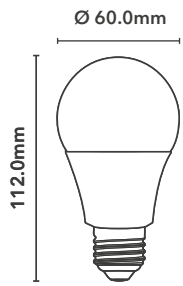

Product Number	Wattage (W)	Equivalent Wattage (W)	Luminous Flux (lm)	Luminous Intensity (cd)	CCT (K)	Beam Angle (°)	Product Weight (g)	Power Factor
52322	8.8	41	490	130	2500	230	124	≥0.90

Mirageball Classic A Photometric Data

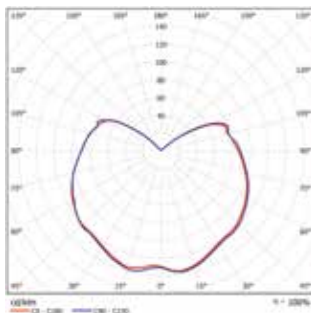

Go to www.verbatimlighting.com for dimmer compatibility information

ADVANCED PRODUCT DESIGN

Mirageball Optics

A problem with many LED non-directional wide beam lamps is that the light output is not uniform which results in shadows or rings. Mitsubishi has created the Mirageball optic lens, using a two-colour moulding process, that delivers a very even and wide angled light that is perfect for decorative fixtures where uniformity is particularly important.

Two-colour moulding, also known as two-material moulding, refers to a process that uses two different types of material for creating one object. For Verbatim's Mirageball lamps, the top frosted part of the lens is made of polycarbonate and diffusing material while the clear/transparent lower part of the lens is made solely of polycarbonate.

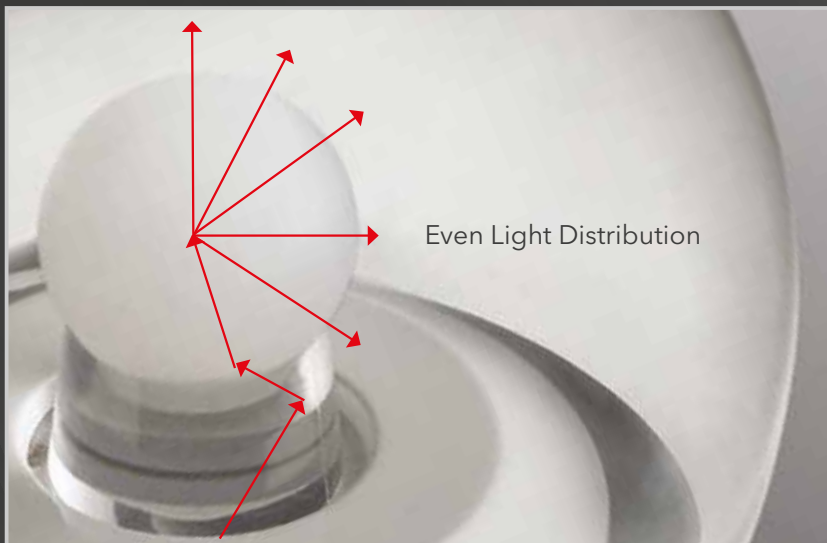



Dichroic LED

Verbatim LED PAR16 and MR16 LED lamps are great replacements for dichroic halogen lamps. Conventional dichroic halogen (also called reflector lamps) produce a glitter surrounding lighting effect thanks to its dichroic reflector that lets IR-Radiation pass to the back. Verbatim's dichroic MR16 and PAR16 match the glitter and the lighting effect of real halogen.



Application

Dichroic lamps are very popular for applications such as track lighting, pendant fixtures and retail display lighting. They produce a unique lighting effect especially suitable for decorative applications.

Ideal for spotlighting and general lighting in public and shopping areas such as reception, bar counter, lounge, display window, corridors, lobbies and conference rooms where the light is used for long periods of time.

PAR16

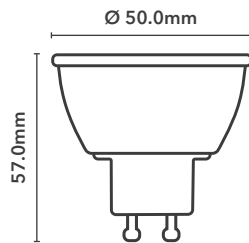

Product Number	Wattage (W)	Equivalent Wattage (W)	Luminous Flux (lm)	Useful Lumen 90° Cone (lm)	Luminous Intensity (cd)	Power Factor
52504	4.0	38	300	250	480	≥0.47

MR16

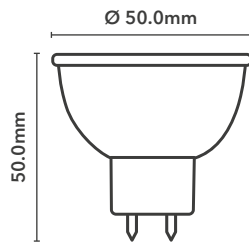

Product Number	Wattage (W)	Equivalent Wattage (W)	Luminous Flux (lm)	Useful Lumen 90° Cone (lm)	Luminous Intensity (cd)	Power Factor
52503	3.7	25	300	250	480	≥0.70

Dichroic LED Photometric Data

52503

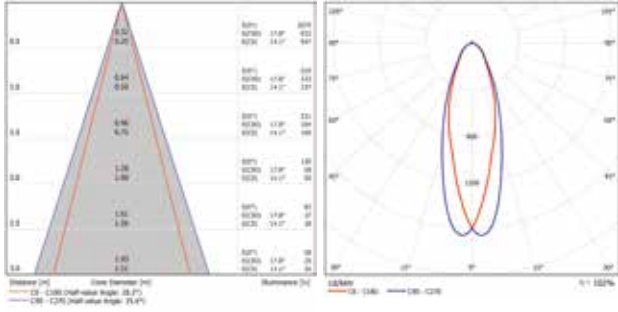

52504

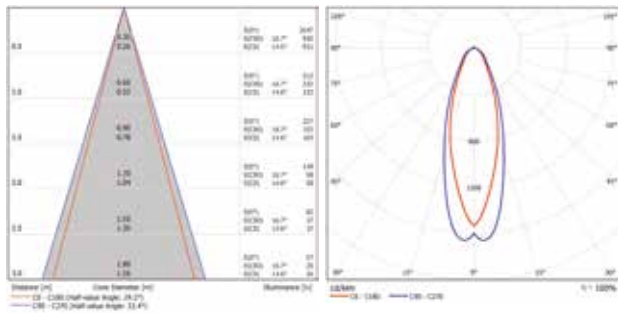



MR16 GU5.3

12 volt driven MR16 LED lamps with bi-pin push-fit GU5.3 base directly replace standard MR16 halogen lamps. Delivering a warm, halogen-like accent beam and offering a very long lifetime, Verbatim has extended its range of retrofit LED lamps for spotlight applications with a line of LED MR16 with the highest luminous efficacy on the market.

The LED MR16 GU5.3 features a unique heatsink designed by parent company Mitsubishi Chemical Corporation and the combination of COB (Chip On Board) LED technology with diamond cut optics.



Application

MR16 GU5.3 LEDs are favoured for directional lighting as well as for mood lighting. They offer flexibility of mounting arrangements where the space is limited.

Ideal for spotlighting and general lighting in public areas such as restaurants, reception, corridors, lobbies and conference rooms and other areas where the light is used for long periods of time.

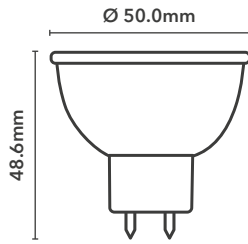

Product Number	Wattage (W)	Equivalent Wattage (W)	Luminous Flux (lm)	Useful Lumen 90° Cone (lm)	Luminous Intensity (cd)	CCT (K)	Lifetime (hours)	Dimmable	Power Factor
52316		38	420	400	1000	2700			
52317	5.5	40	450	430	1100	3000	40,000	Yes	≥0.90
52318		41	470	450	1170				
52321	8.0	52	690	660	1340	4000	30,000	No	

Go to www.verbatimlighting.com for dimmer compatibility information

LED MR16 GU5.3 Photometric Data

52316

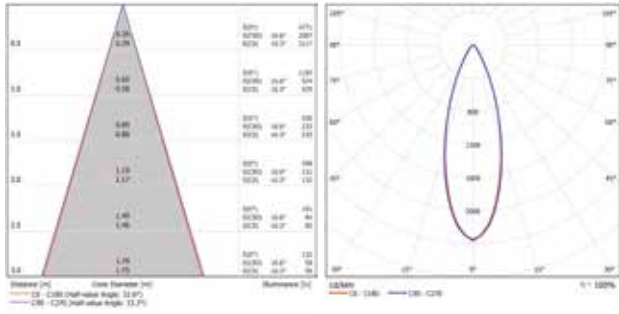

52318

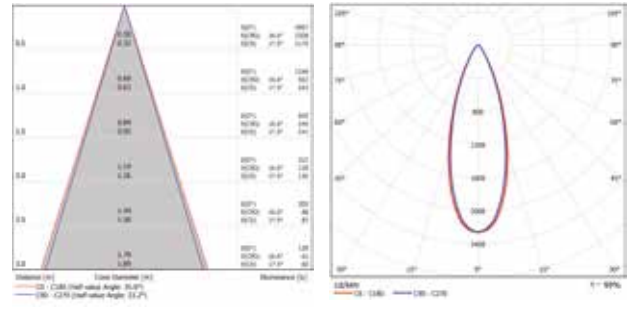

52317

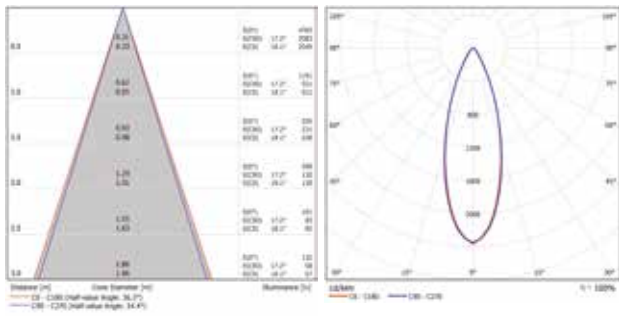

52321

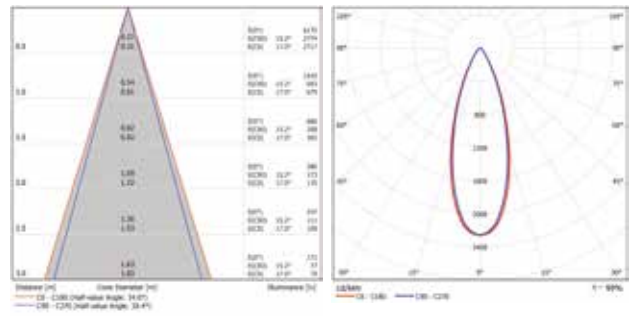



PAR16 GU10

The spot PAR16 GU10 is a great replacement for standard mains voltage halogen lamps. It is energy efficient and has a built-in temperature management control system that guarantees long lifetime. Verbatim LED spot PAR16 GU10 saves up to 91% energy compared to conventional lighting.

The unique heat sink designed by parent company Mitsubishi Chemical Corporation maximizes heat dissipation.

The LED PAR16 GU10 uses a combination of COB (Chip On Board) LED technology and diamond cut optics that create a superb light within a defined beam without multiple shadows and unpleasant glare.



Application

PAR16 GU10 LEDs are favoured for directional lighting and are particularly suitable for working areas as well as for mood lighting. They offer flexibility of mounting arrangements where the space is limited.

Ideal for spotlighting and general lighting in public areas such as restaurants, reception, corridors, lobbies, conference rooms and other areas where the light is used for long periods of time.

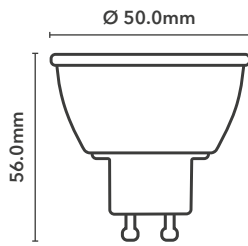

Product Number	Actual Wattage (W)	Equivalent Wattage (W)	Luminous Flux (lm)	Useful Lumen 90° Cone (lm)	Luminous Intensity (cd)	CCT (K)	Power Factor	Lifetime (hours)	Dimmable	Energy Efficiency Class	
52323	4.0	44	320	300	740	2700	≥0.65	50,000		A++	
52324		47	340	320	770	3000					
52312	6.0	57	420	400	1000	2700	≥0.70	40,000	Yes	A+	
52307		61	450	430	1100	3000			No		
52308		64	470	450	1170	4000			≥0.80		No
52306		61	450	430	1100	3000					
52314	8.5	64	470	450	1170	4000	≥0.80	30,000	No	A+	
52313		82	620	590	1180	2700			Yes		
52310		86	650	620	1250	3000					
52311		91	690	660	1340	4000					
52309		86	650	620	1250	3000					
52315		91	690	660	1340	4000		No			

Downlight fittings are also available - please refer to page 76.

Go to www.verbatimlighting.com for dimmer compatibility information

LED PAR16 GU10 Photometric Data

52306

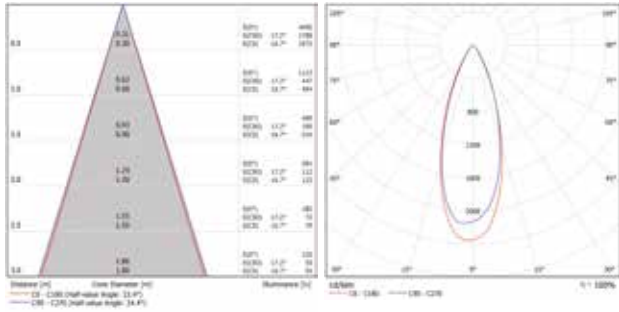

52310

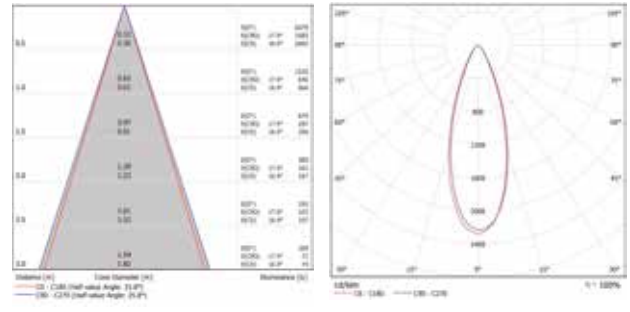

52307

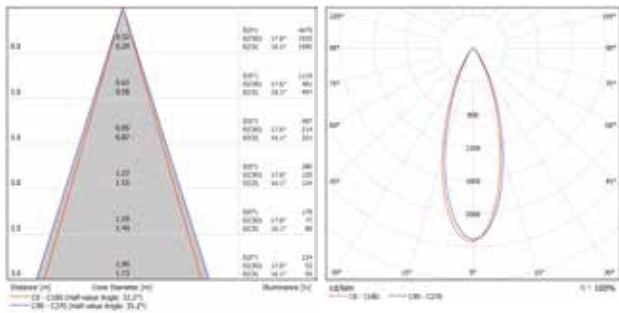

52311

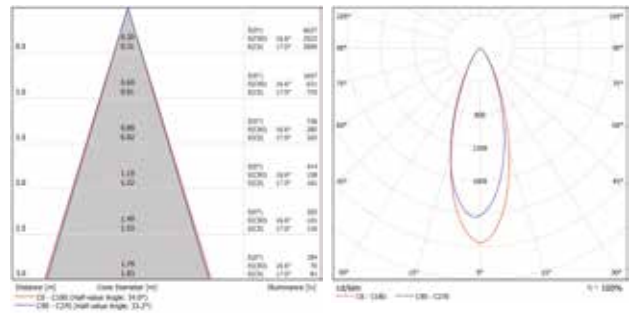

52308

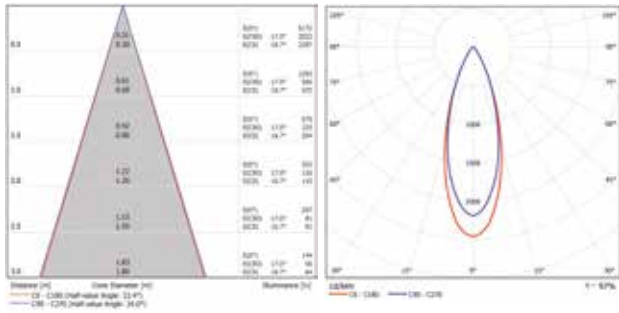

52312

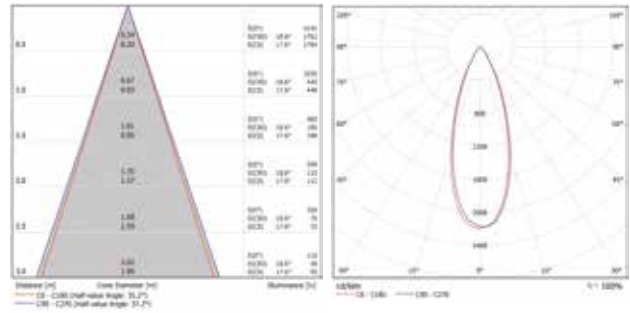

52309

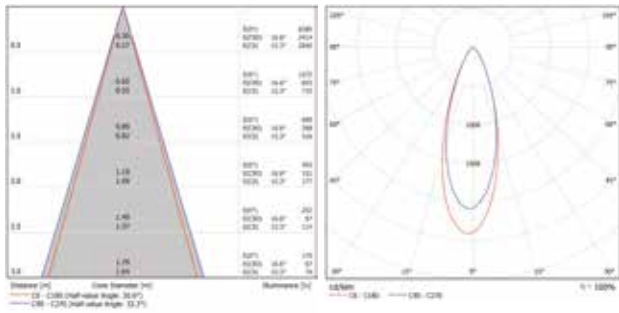

52313

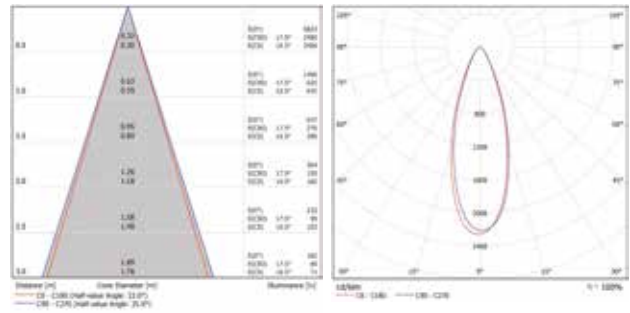

52314

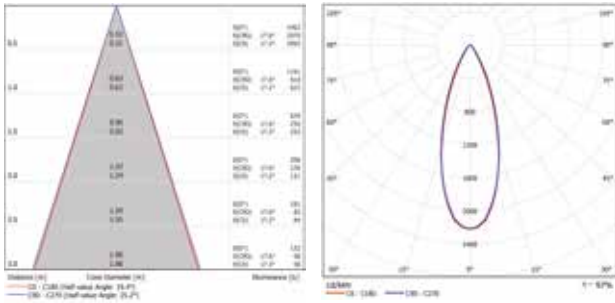

52315

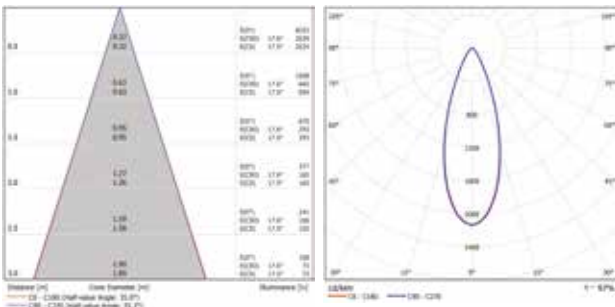

52323

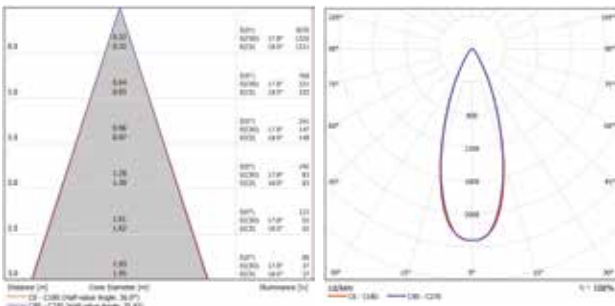

52324

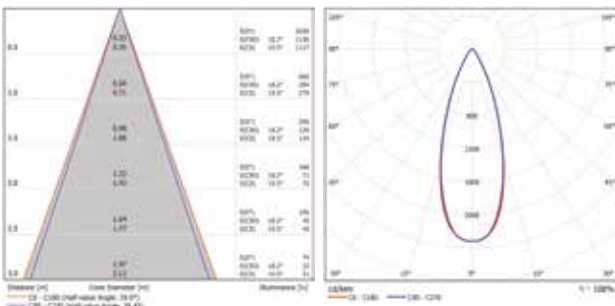

ADVANCED PRODUCT DESIGN

GU10/MR16 Thermal Management

Mitsubishi heatsink technology for optimal thermal management.

Efficient thermal management is related to product reliability and lifetime. Lumen output reduces with rising operating temperature, so thermal management is vital to the performance of LEDs.

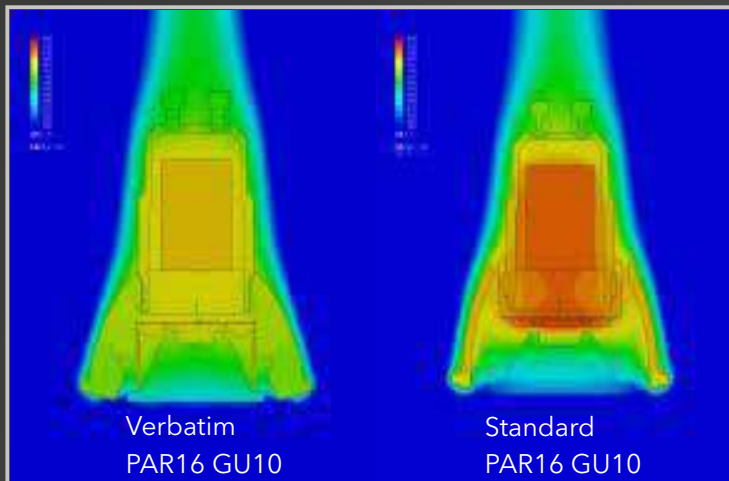

Mitsubishi's uniquely designed heat sink air flow cooling system delivers very effective thermal management, reducing the temperature by 20% compared to standard heat sinks which in turn makes it extremely reliable

The LED GU10/MR16 use a combination of COB (Chip On Board) LED technology and diamond cut optics that gives these lamps a highly desired halogen effect with perfect beam control. This helps to minimize spill light and avoid multiple shadows and unpleasant glare that is sometimes a factor in spotlights.



The sophisticated matt grey finished heatsink looks good and is compatible with standard fixtures. However, its key attribute is that it maximizes the heat transfer and dissipation performance by optimizing its shape and fin arrangement for self cooling by convection of the surrounding air, conduction through the air, and radiation.

The single light source with the diamond-cut reflector and fly-eye optics provides well controlled beam and minimized glare.



249.



Downlight Fittings for LED PAR16 GU10

Verbatim downlight fittings are perfect for all Verbatim LED PAR16 GU10 lamps.

They are available in packs which consist of a white or aluminium fixed ring plus a holding pin, a GU10 socket and an electrical connection box.

Available in two different IP protection ratings, the IP23 rated version is suitable for general-purpose lighting while the IP44 version offers better water resistance making it ideal for lighting in bathrooms and other damp rooms.



Application

Economic solution for general lighting in corridors, offices, shops or in domestic households, in living rooms, kitchens, bedrooms or bathrooms.

52400 / 52401

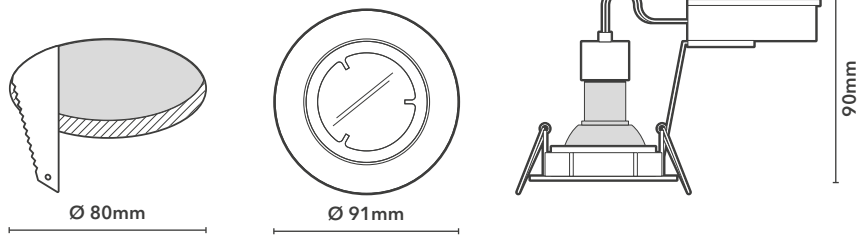

52402 / 52403

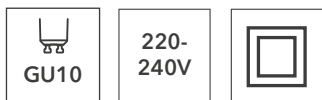
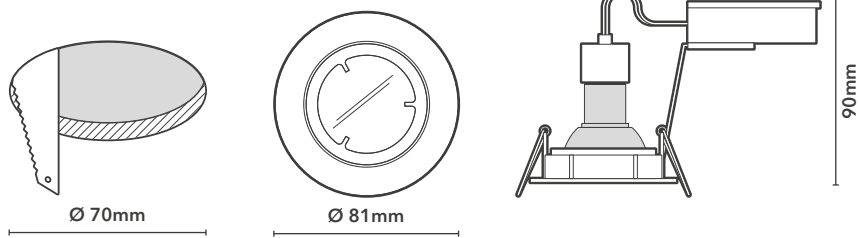

Product Number	Tilting Angle (°)	Housing Colour	Product Weight (g)	Protection Class
52400	40	White	140	IP23
52401	40	Brushed Aluminium		
52402	-	White		IP44
52403	-	Brushed Aluminium		

Recommended for use with Verbatim LED PAR16 GU10 lamps - see page 70.

LED AR111

Verbatim's anti-glare AR111 LED lamp serves as a true performance plug-in halogen lamp replacement. To avoid the uncomfortable glare from the central beam that often characterizes rival LED products, Verbatim's retrofit 10.5W AR111s feature a unique design that emits light indirectly using the reflector.



Application

Ideal for general lighting and spotlighting in public areas such as lobbies, corridors, stairwells and shops where the light is used for long periods of time.

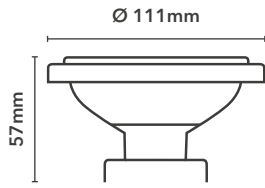

Product Number	Actual Wattage (W)	Equivalent Wattage (W)	Luminous Flux (lm)	Useful Lumen 90° Cone (lm)	Luminous Intensity (cd)	Beam Angle (°)	CCT (K)	Power Factor
52329	10.5	85	700	680	6000	12	2700	≥0.90
52330		88	720	700	6500		3000	
52326		70	700	680	1700		2700	
52327		72	720	700	1800	25	3000	
52328		76	750	740	1900		4000	
52331		70	700	680	1500	40	2700	
52332		72	720	700	1600		3000	

Go to www.verbatimlighting.com for dimmer compatibility information

LED AR111 Photometric Data

52326

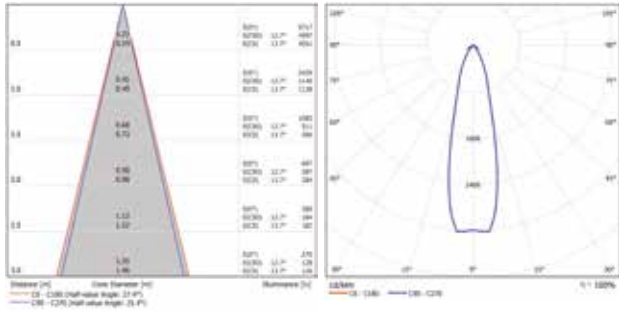

52330

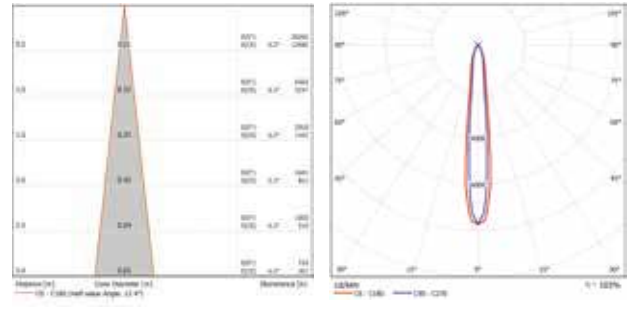

52327

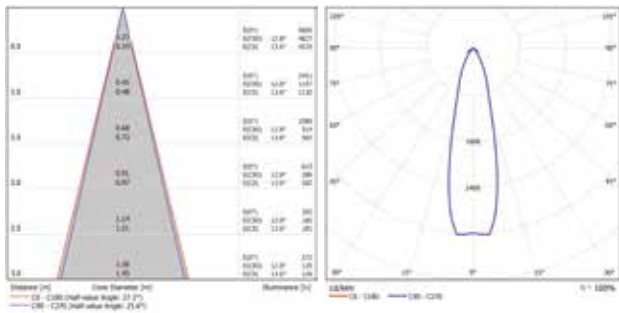

52331

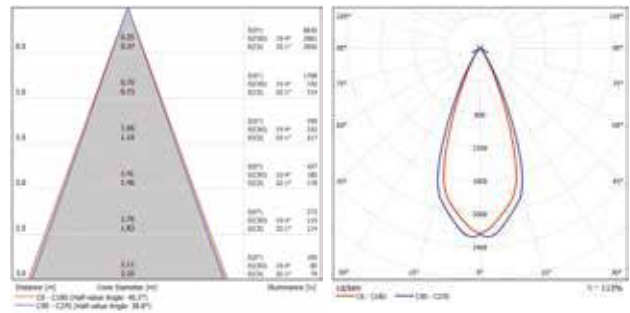

52328

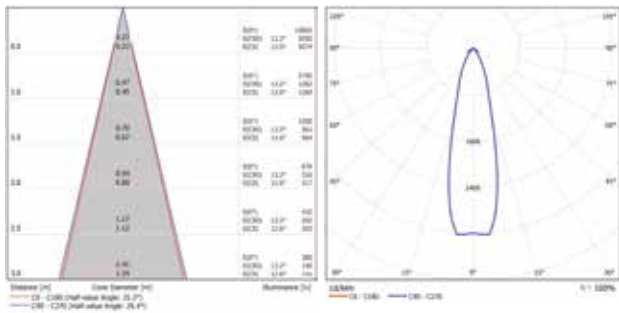

52332

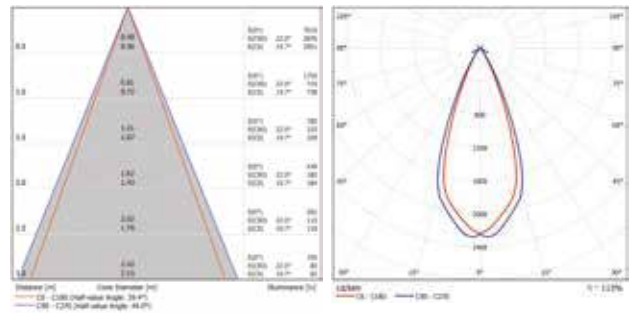

52329

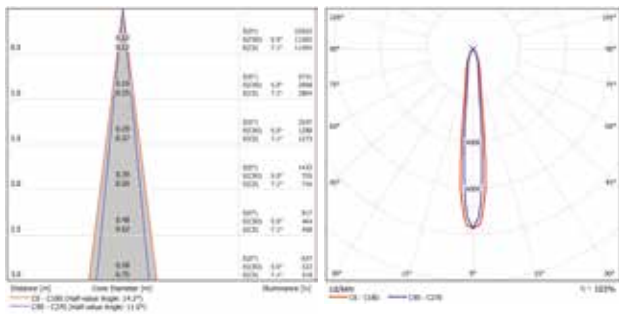



Boconcept, Germany's

ADVANCED PRODUCT DESIGN

AR111 Optimized thermal control design

Developed by Mitsubishi Chemical, the AR111 weighs just 100g and its shape and dimensions enable the lamp to be physically compatible with all different types of AR111 fixtures, something rival products do not achieve without sacrificing reliability and energy efficiency. A special thermal control system enables a compact size which is a major advantage given traditional LED AR111s usually feature a heatsink design that is too bulky for seamless substitution with halogen lamps.

The entire body of the lamp is designed to be most functional. The reflector of the lamp is designed to not only control the light but to also dissipate the heat across its entire surface. This helps to achieve a very long life span for the lamp without the requirement of an additional heatsink.

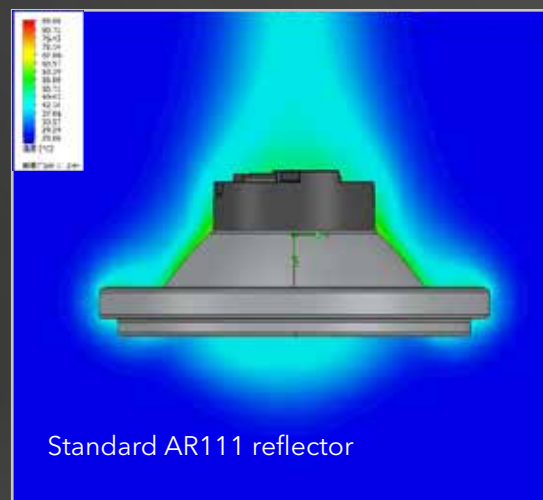
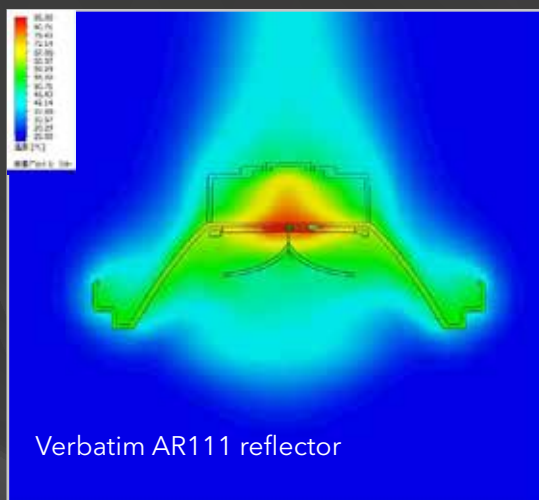



LED T8 Tubes

Verbatim LED T8 tubes are a mercury-free, flicker-free and instant-on alternative for fluorescent tubes in T8 fixtures with conventional control gear. Available in three different colour temperatures, they provide high energy savings with a long lifetime of 70.000 hours. A replacement starter is included with every tube.



Application

Ideal for general lighting in car parks, garages, offices, workshops and warehouses.

52706 / 52707

52709 / 52710

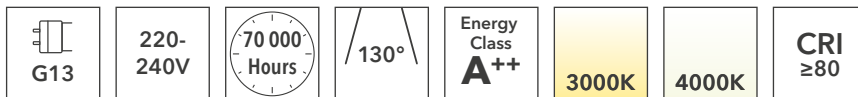
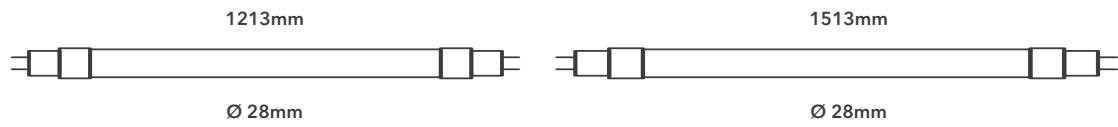

Product Number	Wattage (W)	Luminous Flux (lm)	CCT (K)	Product Weight (g)
52706	18	2200	3000	270
52707		2300	4000	
52709	23	2800	3000	350
52710		2950	4000	

LED T8 Tubes Photometric Data

52706

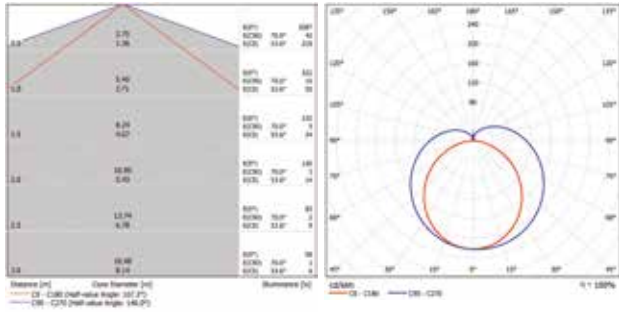

52709

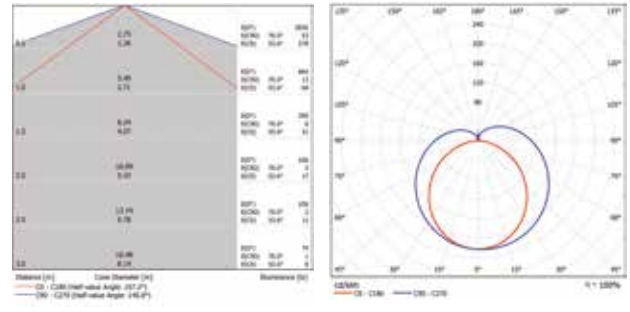

52707

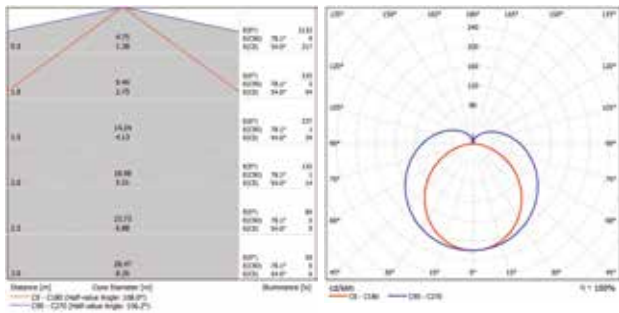

52710

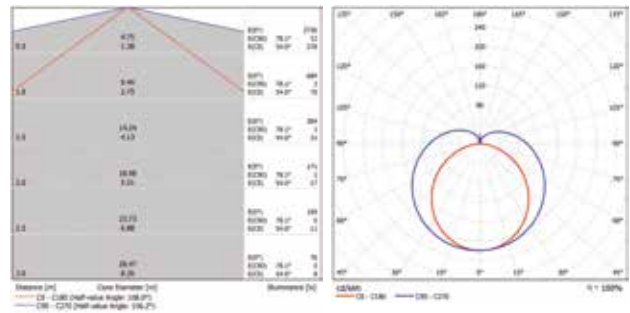



Electronic Transformer for 12V LED lamps

A 12V LED-compatible electronic transformer offering high efficiency, greater than 95%. The transformer is dimmable with recommended dimmers and a constant voltage. It has a long lifetime of over 50,000 hours.

Application

Suitable for all Verbatim LED MR16 and AR111.

Type	Electronic Transformer
Product number	52900
Primary voltage range	220-240V
Frequency	50/60Hz
Input current	0.29A
Secondary voltage	11.5VAC
Lamp wattage	Halogen: 0-70W LED lamp: 0-45W recommended
Efficiency	>95%
Power factor	>0.99
Input capacitance	100 nF
Dimming	Leading and trailing edge dimmers
Dimensions L x W x H	113 x 44 x 28mm
Weight	80g
Safety class	II



TOOLS

Dimmer compatibility tool

Verbatim recognizes the market's increasing need for dimmable products and provide a number of compatible combinations of major brand dimmers and Verbatim dimmable LED lamps and luminaires based on our internal testing conducted in a laboratory environment.

Verbatim's LED retrofit lamps work with a wide range of common leading and trailing edge dimmers on the market. Because there is no general compatibility between all dimmers available on the market, Verbatim has provided for each product a compatibility list with recommended dimmers and also drivers in the case of 12V lamps, on its website <http://www.verbatim-europe.com/en/led/dimmercompatibility/>



The information can be searched by a dimmer finder. Just type in the product code of the selected product, press enter, and you will find a list of compatible dimmers and drivers that work smoothly with Verbatim's products.

Dialux PlugIn





DIALux DIAL has developed and continues to develop a planning tool for indoor and outdoor lighting design. DIALux not only makes professional lighting design simpler and accessible for everyone, but as a platform and tool, it is a network for designers and manufacturers all over the world.

You can now download the DIALux plug-in for simple, effective and professional lighting design with Verbatim's LED product range. Verbatim Plug-in is available for download on Verbatim website <http://www.verbatim-europe.co.uk/en/led/dialux/>. You can take full advantage of this advanced software to create your own lighting scenes enabled by Verbatim lighting products.



Pictograms



Base: the base of a lamp is the part that provides electrical and mechanical connection to the light fixture. A standardized system of lamp bases guarantees interoperability and easy replacement. Verbatim offers LED lamps with the most commonly used lamp bases.

-  E27
-  G13
-  G53
-  GU10
-  GU5.3

Beam angle: defined as the angle at which the luminous intensity of a directional light source is 50% of the maximum light intensity of emitted light. It is the angle between peak intensity and 50% of peak intensity at full width - referring to both sides of the beam axis.



Colour: indicates the housing colour (black, white, silver) of the product.

- 
- 
- 

Colour rendering index (CRI): describes the colour rendering properties, the visual appearance of objects lit by a light source, compared to a reference source of the same colour temperature. On a scale from 0 to 100, it indicates the ability to faithfully reveal colours and depends on the spectrum of the light source.



Colour temperature in Kelvin (K): is the colour appearance of light in comparison to an ideal black body radiator. According to EN12464, colour temperatures are classified in 3 groups: Warm white (<3300K), neutral or intermediate white (3300K-5300K) and cold white (>5300K).



DALI: Digital Addressable Lighting Interface - DALI is a global standard and open protocol for communications and control of lighting equipment including control gears and control devices. It guarantees interoperability with DALI system components and intelligent control of lighting.



Dimmable via leading and trailing edge.



Energy class: the energy classes according to EU Directive 1194/2012 categorize energy efficiency and eco-design requirements for directional and non-directional LED lamps. Verbatim's LED lamp feature energy classes from A to A++.



IPXX

Ingress protection: the IP (ingress protection) rating indicates the level of protection against intrusion and water. The first digit refers to the protection from solid objects whereas the second digit indicates protection from liquids. Generally, the higher the value, the more protected a LED device is against either intrusion or water - starting with "0" for no protection at all.

Installation: to be installed in an open fixture



Lifetime (L70) in hours: defined as the time until the light output of a LED device has decreased to 70% of the initial output. It also refers to lumen depreciation which is the decrease in lumen output that occurs as a LED device is operated.



Safety class: the safety classes define the protection and insulation requirements against electric shock. Whereas protection in Class III for low voltage lighting relies only on supply at SELV, Class I requires means of earthing and Class III double-insulated safety precautions.

Class I

 Luminaires in this class are electrically insulated and provided with a connection to earth. Earthing protects exposed metal parts that could become live in the event of basic insulation failure.

Class II

 Luminaires in this class are designed and constructed so that protection against electric shock does not rely on basic insulation only. This can be achieved by means of reinforced or double insulation. No provision for earthing is required.

Class III

 Here protection against electric shock relies on supply at Safety Extra - Low Voltage (SELV) and in which voltages higher than those of SELV are not generated (max. 50V ac rms).

Voltage: indicates the voltage that is required to operate the LED device. For operating 12V LED lamps, an additional electric transformer is required (see page 88).



Weight: indicates the weight of the product measured in grams (g).



1-10V

 1-10V analog dimmable lighting system via a two-wire, low-voltage control line connecting control gear and controllers. Light levels are scaled so that at 10V, the controlled light is at 100% of its potential output whereas 1V signifies 10% of the potential light output

850 °C

 **850°C glow wire test:** the glow wire test according to EN 60695-2 is used to test flammability and fire resistance of a product. All Verbatim's LED devices pass the glow wire test at 650°C. If stated differently, the test has been conducted at 850°C.

Product Number Index

Product Number	Page	Product Number	Page	Product Number	Page	Product Number	Page
52246	40	52316	66	52431	50	52707	84
52247	40	52317	66	52434	50	52709	84
52248	40	52318	66	52435	50	52710	84
52249	40	52321	66	52436	30	52900	88
52250	40	52322	58	52437	30	52902	41
52251	40	52323	70	52438	30	52903	41
52258	40	52324	70	52439	30	52905	51
52259	40	52326	78	52444	22	52906	31
52267	18	52327	78	52445	22	52908	31
52268	18	52328	78	52446	22	52909	31
52270	18	52329	78	52447	22	52911	31
52271	18	52330	78	52448	22	52912	23
52278	46	52331	78	52449	22	52913	23
52279	46	52332	78	52450	22	52914	23
52280	46	52336	56	52451	22	52915	23
52281	46	52337	56	52452	34	52917	35
52282	46	52338	56	52453	34	52918	35
52283	46	52339	56	52454	34	52919	35
52306	70	52400	76	52455	34	52920	35
52307	70	52401	76	52456	34	52921	35
52308	70	52402	76	52457	34	52922	35
52309	70	52403	76	52493	14	52924	41
52310	70	52408	26	52494	14	52925	41
52311	70	52409	26	52497	14	52926	41
52312	70	52410	26	52498	14	52927	41
52313	70	52411	26	52503	62	52928	41
52314	70	52429	34	52504	62	52932	47
52315	70	52430	50	52706	84	52933	47

Verbatim - France & Portugal

Immeuble Hermes, 20 rue Jacques Daguerre,
92565 Rueil-Malmaison Cedex

France

T: +33 (0) 1 47 16 94 20

F: +33 (0) 1 47 16 15 00

E: info.france@verbatim-europe.com /

Verbatim - Africa, Middle East & Turkey

First Floor, Building 4, Pinewood Office Park,
33 Riley Road, Woodmead,

South Africa

T: +27 (0) 11 253 4940

F: +27 (0)11 234 3626

E: info.sa@verbatim-europe.com

**Verbatim - Germany, Austria, Switzerland,
Central/East Europe, Russia, Commonwealth
of Independent States**

Düsseldorfer Str. 13, D - 65760 Eschborn

Germany

T: +49 (0) 6196 900 10

F: +49 (0) 6196 900 120

E: info.germany@verbatim-europe.com /

E: info.central-east@verbatim-europe.com

**Verbatim - United Kingdom, Ireland, Norway,
Sweden, Denmark, Finland, Iceland & Israel
(EMEA Head Office)**

Prestige House, 23-26 High Street, Egham, Surrey
TW20 9DU,

United Kingdom

T: +44 (0) 1784 439 781

F: +44 (0) 1784 471 337

E: info.uk@verbatim-europe.com

<https://twitter.com/verbatimled>

Verbatim - Italy, Cyprus, Greece & Malta

Via Roma 108 , 20060 Cassina de' Pecchi MI

Italy

T: +39 02 9530 1115

F: +39 02 9530 0449

E: info.italy@verbatim-europe.com

- EUROPE/ MIDDLE EAST/ AFRICA: Verbatim Ltd, Prestige House, 23- 26 High Street, Egham, Surrey, TW20 9DU, UK
- AMERICAS: USA Verbatim Americas LLC. Charlotte, NC
- AUSTRALIA/ NEW ZEALAND: Verbatim Australia Pty Ltd, Unit 6, 450 Princes Highway, Noble Park, Victoria, 3174 Australia
Tel: +61 3 9790 8999 Fax:+61 3 9790 8955 Email:support@verbatim.com.au

銷售公司：香港威寶有限公司

公司地址：香港九龍尖沙咀東部加連威老道92號

幸福中心1101-2室

銷售公司：威宝国际贸易(深圳)有限公司

公司地址：深圳市福田区泰然九路海松大厦B座1406室

台灣地區

委製商/進口商：台灣威寶國際貿易股份有限公司

公司地址：台北市基隆路二段166號4樓

聯絡電話：02-23771698

"VERBATIM" and  logo are trademarks, please refer to www.verbatim.com/trademarks

**Verbatim - The Netherlands, Belgium &
Luxembourg**

Laan van Zuid Hoorn 14, 2289 DE Rijswijk,

The Netherlands

T: +31 (0)70 336 76 00

F: +31 (0)70 336 76 11

E: info.nl@verbatim-europe.com